

描述 / Descriptions

TO-220 塑封封装 PNP 半导体三极管。Silicon PNP transistor in a TO-220 Plastic Package.

特征 / Features

与 2N6123 互补。

Complement to 2N6123.

用途 / Applications

用于中功率线性开关。

Medium power linear switching applications.

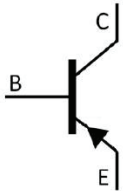
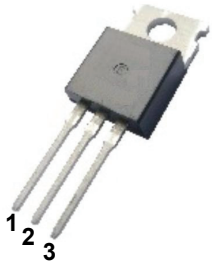
内部等效电路 / Equivalent Circuit**引脚排列 / Pinning**

PIN 1 : Base

PIN 2 : Collector

PIN 3 : Emitter

放大及印章代码 / h_{FE} Classifications & Marking

见印章说明。See Marking Instructions.

极限参数 / Absolute Maximum Ratings(Ta=25°C)

参数 Parameter	符号 Symbol	数值 Rating	单位 Unit
Collector to Base Voltage	V_{CBO}	-80	V
Collector to Emitter Voltage	V_{CEO}	-80	V
Emitter to Base Voltage	V_{EBO}	-5.0	V
Collector Current - Continuous	I_C	-4.0	A
Peak Collector Current	I_{CM}	-7.0	A
Base Current - Continuous	I_B	-1.0	A
Collector Power Dissipation	$P_C(T_C=25^\circ\text{C})$	40	W
Junction Temperature	T_j	150	°C
Storage Temperature Range	T_{stg}	-55~150	°C

电性能参数 / Electrical Characteristics(Ta=25°C)

参数 Parameter	符号 Symbol	测试条件 Test Conditions	最小值 Min	典型值 Typ	最大值 Max	单位 Unit
Collector to Base Breakdown Voltage*	* V_{CEO}	$I_C=-100\text{mA}$ $I_B=0$	-80			V
Collector to Emitter Breakdown Voltage	V_{CBO}	$I_C=-1\text{mA}$ $I_E=0$	-80			V
Emitter to Base Breakdown Voltage	V_{EBO}	$I_E=-1\text{mA}$ $I_C=0$	-5.0			V
Collector Cut-Off Current	I_{CBO}	$V_{CB}=-80\text{V}$ $I_E=0$			-0.1	mA
Collector Cut-Off Current	I_{CEO}	$V_{CE}=-80\text{V}$ $I_B=0$			-1.0	mA
Emitter Cut-Off Current	I_{EBO}	$V_{EB}=-5.0\text{V}$ $I_C=0$			-1.0	mA
DC Current Gain	* $h_{FE(1)}$	$V_{CE}=-2.0\text{V}$ $I_C=-1.5\text{A}$	20		80	
	* $h_{FE(2)}$	$V_{CE}=-2.0\text{V}$ $I_C=-4.0\text{A}$	7.0			
Collector to Emitter Saturation Voltage*	* $V_{CE(sat)}$	$I_C=-1.5\text{A}$ $I_B=0.15\text{A}$			-0.6	V
	* $V_{CE(sat)}$	$I_C=-4.0\text{A}$ $I_B=-1.0\text{A}$			-1.4	V
Base to Emitter On Voltage*	* $V_{BE(on)}$	$I_C=-1.5\text{A}$ $V_{CE}=-2.0\text{V}$			-1.2	V
Transition Frequency	f_T	$I_C=-1.0\text{A}$ $V_{CE}=-4.0\text{V}$ $f=1.0\text{MHz}$	2.5			MHz

*Pulse test: pulse width $\leq 300 \mu\text{s}$; duty cycle $\leq 2\%$.

*脉冲测试：脉宽 $\leq 300\mu\text{s}$ ；占空比 $\leq 2\%$ 。

电参数曲线图 / Electrical Characteristic Curve

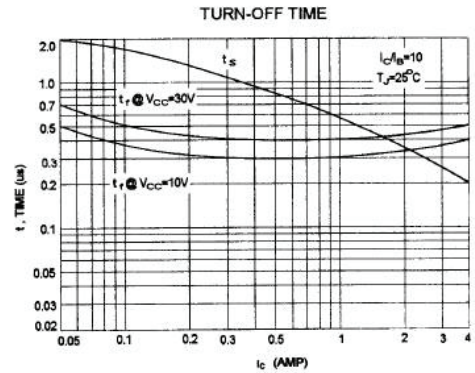
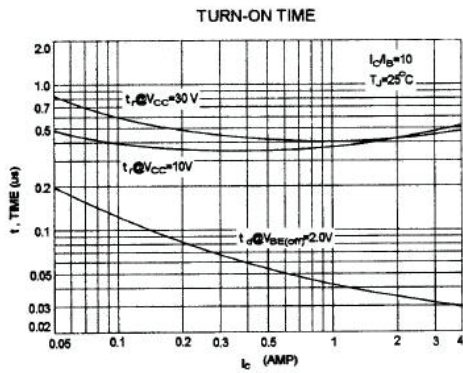
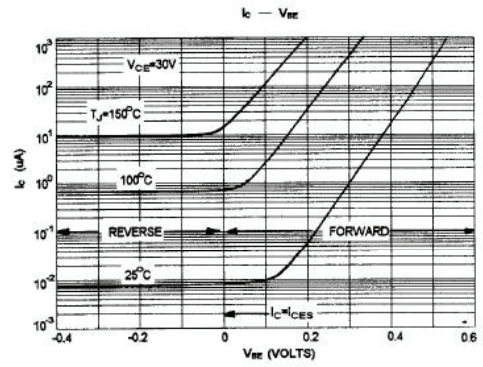
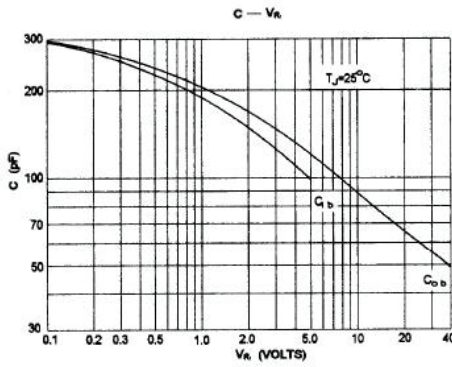
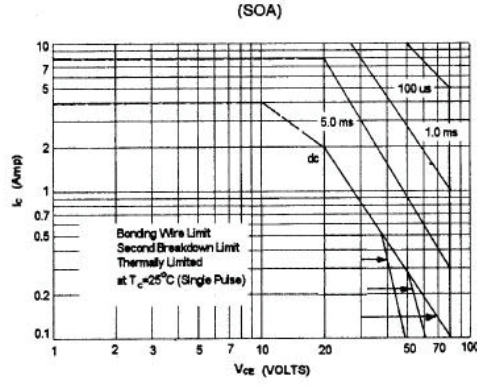

外形尺寸图 / Package Dimensions

TO-220

单位: mm

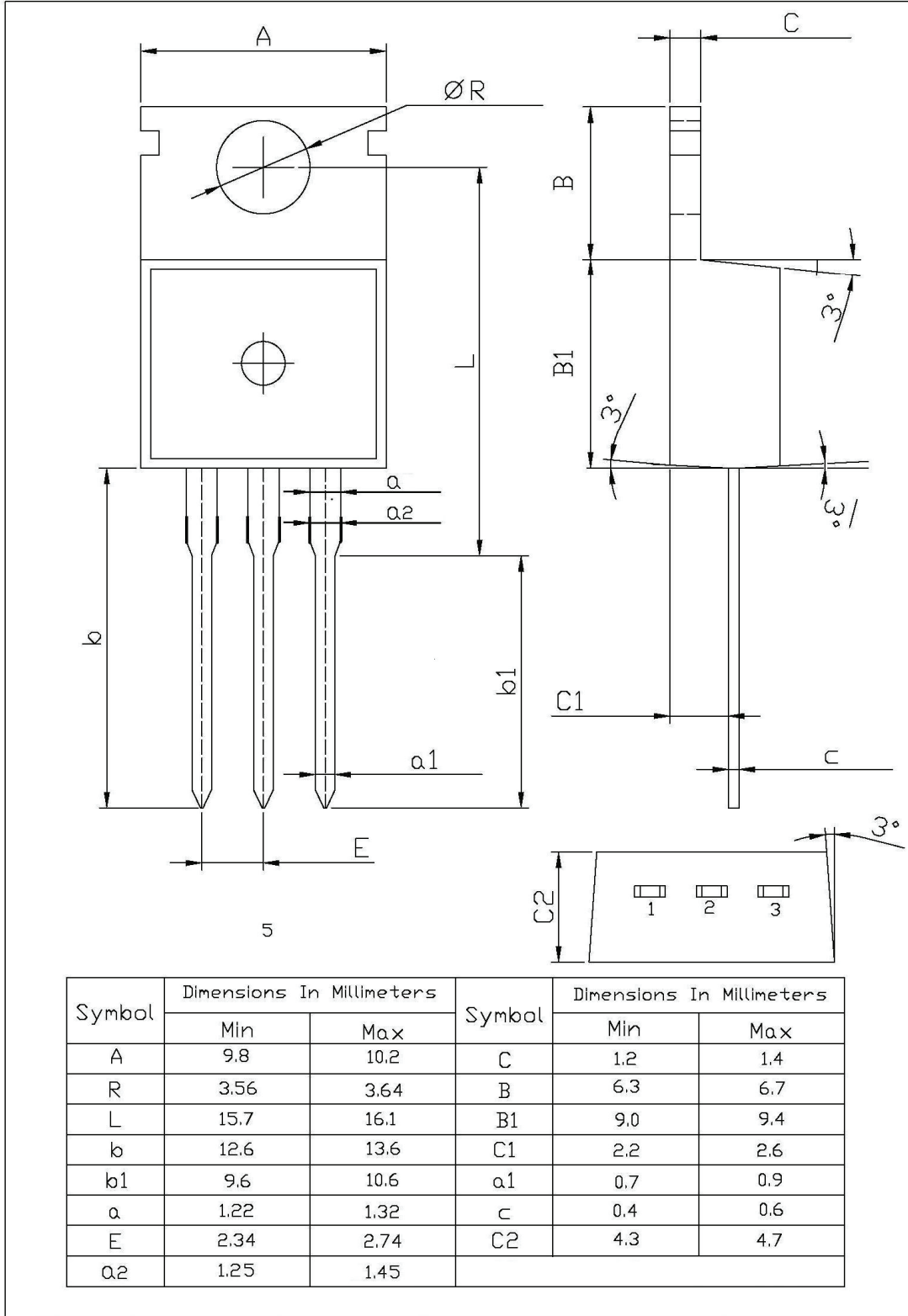

印章说明 / Marking Instructions

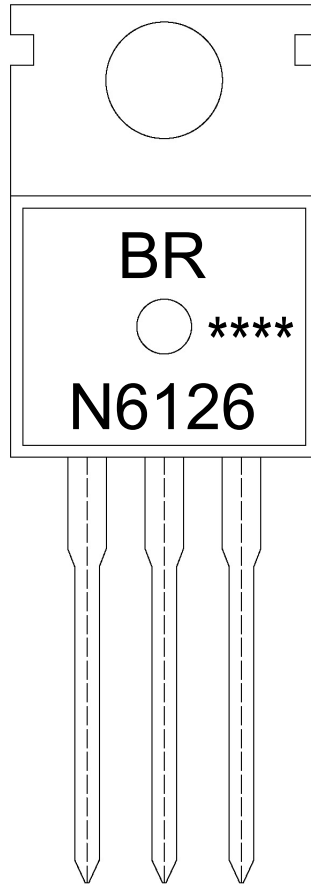

说明：

BR： 为公司代码

N6126： 为型号代码

****： 为生产批号代码，随生产批号变化。

Note:

BR: Company Code

N6126: Product Type.

****: Lot No. Code, code change with Lot No.

波峰焊温度曲线图(无铅) / Temperature Profile for Dip Soldering(Pb-Free)

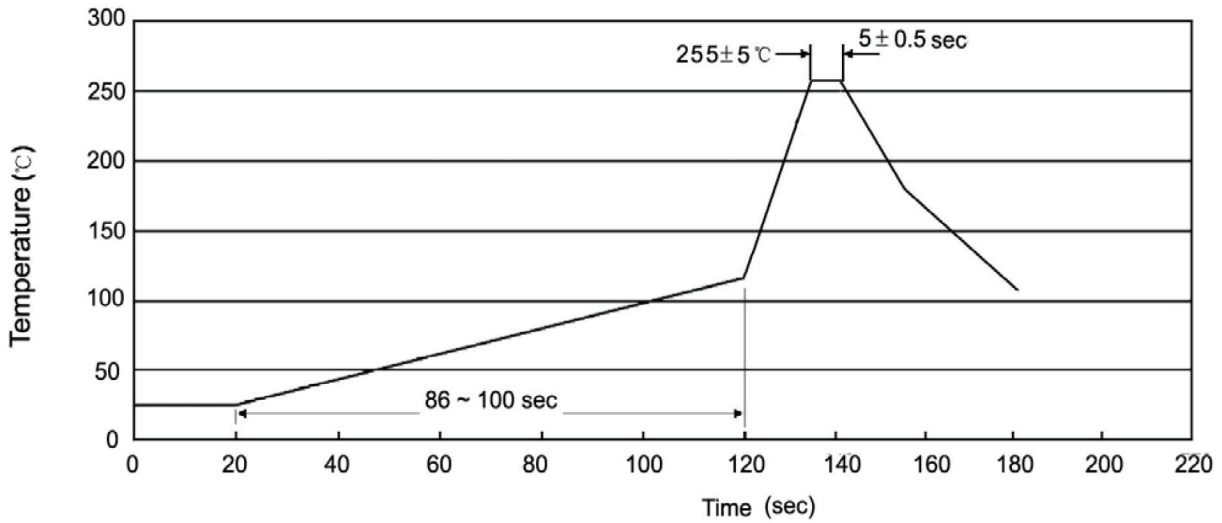

说明：

- 1、预热温度 25 ~ 150°C，时间 60 ~ 90sec；
- 2、峰值温度 255±5°C，时间持续为 5±0.5sec；
- 3、焊接制程冷却速度为 2 ~ 10°C/sec.

Note:

- 1.Preheating:25~150°C, Time:60~90sec.
- 2.Peak Temp.:255±5°C, Duration:5±0.5sec.
3. Cooling Speed: 2~10°C/sec.

耐焊接热试验条件 / Resistance to Soldering Heat Test Conditions

温度：270±5°C

时间：10±1 sec.

Temp.:270±5°C

Time:10±1 sec

包装规格 / Packaging SPEC.

散件包装 / BULK

Package Type 封装形式	Units 包装数量					Dimension 包装尺寸 (unit: mm ³)		
	Units/Bag 只/袋	Bags/Inner Box 袋/盒	Units/Inner Box 只/盒	Inner Boxes/Outer Box 盒/箱	Units/Outer Box 只/箱	Bag 袋	Inner Box 盒	Outer Box 箱
TO-220/F	200	10	2,000	5	10,000	135×190	237×172×102	560×245×195

套管包装 / TUBE

Package Type 封装形式	Units 包装数量					Dimension 包装尺寸 (unit: mm ³)		
	Units/Tube 只/套管	Tubes/Inner Box 套管/盒	Units/Inner Box 只/盒	Inner Boxes/Outer Box 盒/箱	Units/Outer Box 只/箱	Tube 套管	Inner Box 盒	Outer Box 箱
TO-220/F	50	20	1,000	5	5,000	532×31.4×5.5	555×164×50	575×290×180

使用说明 / Notices