

2SC1473(A)

Rev.E Mar.-2016

描述 / Descriptions

TO-92 塑封封装 NPN 半导体三极管。Silicon NPN transistor in a TO-92 Plastic Package.

特征 / Features

耐压高,特征频率 f_T 高,与 2SA1018(A)互补。

High V_{CE0} , high f_T , Complementary pair with 2SA1018(A).

用途 / Applications

用于普通放大。

General amplifier applications.

内部等效电路 / Equivalent Circuit

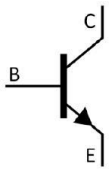

引脚排列 / Pinning



PIN1 : Base

PIN 2 : Collector

PIN 3 : Emitter

放大及印章代码 / h_{FE} Classifications & Marking

| h_{FE} Classifications Symbol | P | Q | R |
|------------------------------------|--------|--------|---------|
| h_{FE} Range | 30~100 | 60~150 | 100~220 |

极限参数 / Absolute Maximum Ratings(Ta=25°C)

| 参数 Parameter | 符号 Symbol | 数值 Rating | 单位 Unit |
|---------------------------------------|------------------|--------------|------------|
| Collector to Base Voltage | V _{CBO} | 2SC1473 | 250 |
| | | 2SC1473A | 300 |
| Collector to Emitter Voltage | V _{CEO} | 2SC1473 | 200 |
| | | 2SC1473A | 300 |
| Emitter to Base Voltage | V _{EBO} | 7.0 | V |
| Collector Current - Continuous | I _C | 70 | mA |
| Collector Current – Continuous(Pulse) | I _{CP} | 100 | mA |
| Collector Power Dissipation | P _C | 750 | mW |
| Junction Temperature | T _j | 150 | °C |
| Storage Temperature Range | T _{stg} | -55~150 | °C |

电性能参数 / Electrical Characteristics(Ta=25°C)

| 参数 Parameter | 符号 Symbol | 测试条件 Test Conditions | 最小值 Min | 典型值 Typ | 最大值 Max | 单位 Unit |
|--|----------------------|--|------------|------------|------------|------------|
| Collector to Breakdown Emitter Voltage | V _{CEO} | I _C =100μA I _B =0 | 200 | | | V |
| | | | 300 | | | |
| Emitter to Base Breakdown Voltage | V _{EBO} | I _E =1.0μA I _C =0 | 7.0 | | | V |
| Collector Cut-Off Current | I _{CEO} | V _{CE} =120V I _B =0 | | | 1.0 | μA |
| DC Current Gain | h _{FE} | V _{CE} =10V I _C =5.0mA | 30 | | 220 | |
| Collector to Emitter Saturation Voltage | V _{CE(sat)} | I _C =50mA I _B =5.0mA | | | 1.5 | V |
| Transition Frequency | f _T | V _{CE} =10V I _C =10mA | 50 | | | MHz |
| Collector Output Capacitance | C _{ob} | V _{CB} =10V I _E =0 f=1.0MHz | | | 10 | pF |

电参数曲线图 / Electrical Characteristic Curve

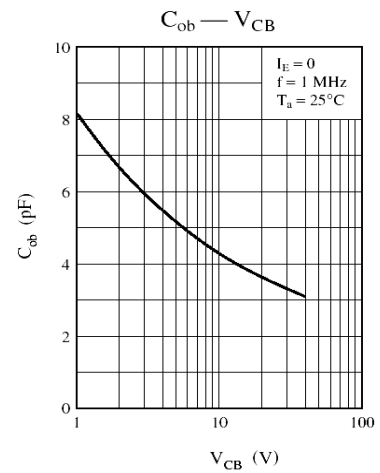
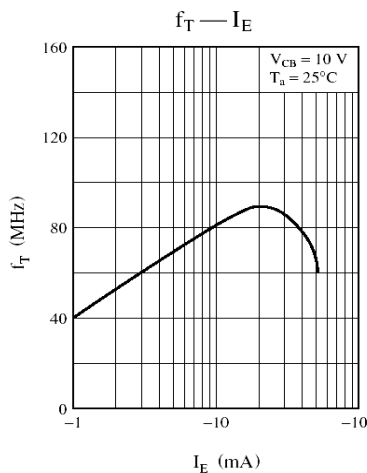
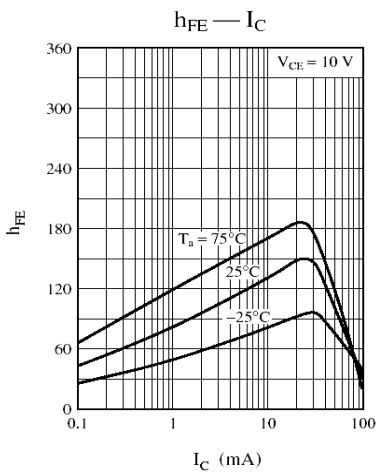
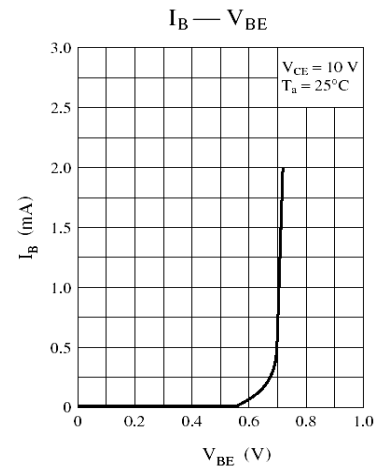
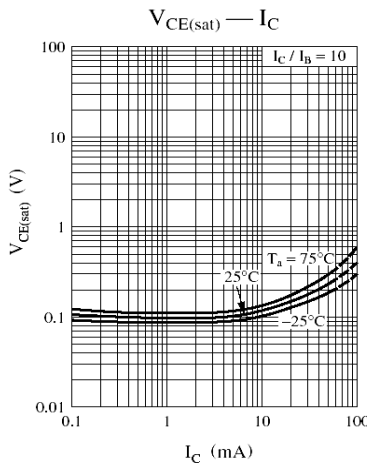
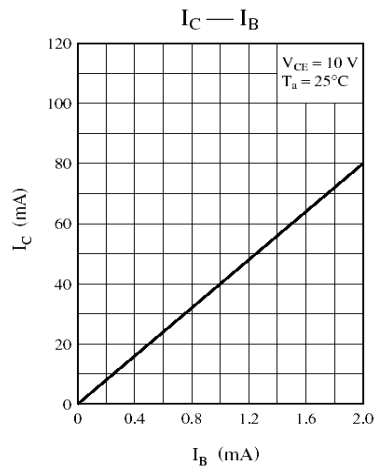
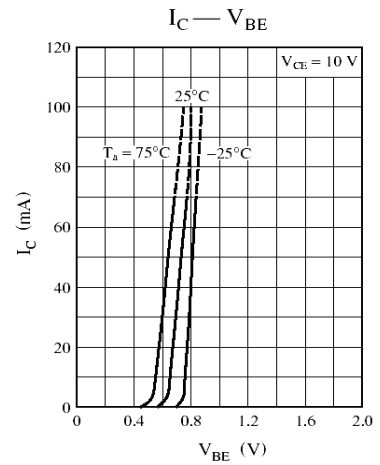
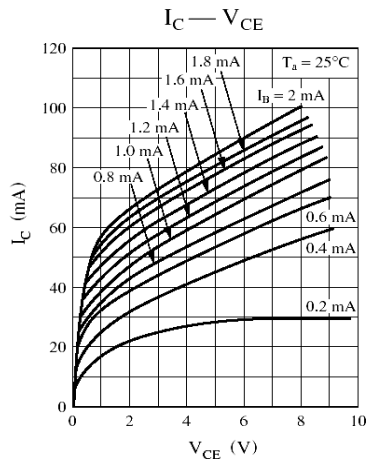
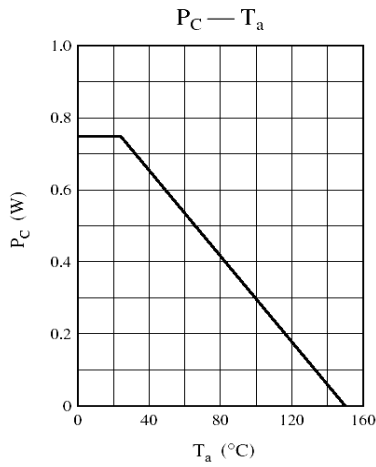

外形尺寸图 / Package Dimensions

TO-92

Unit: mm

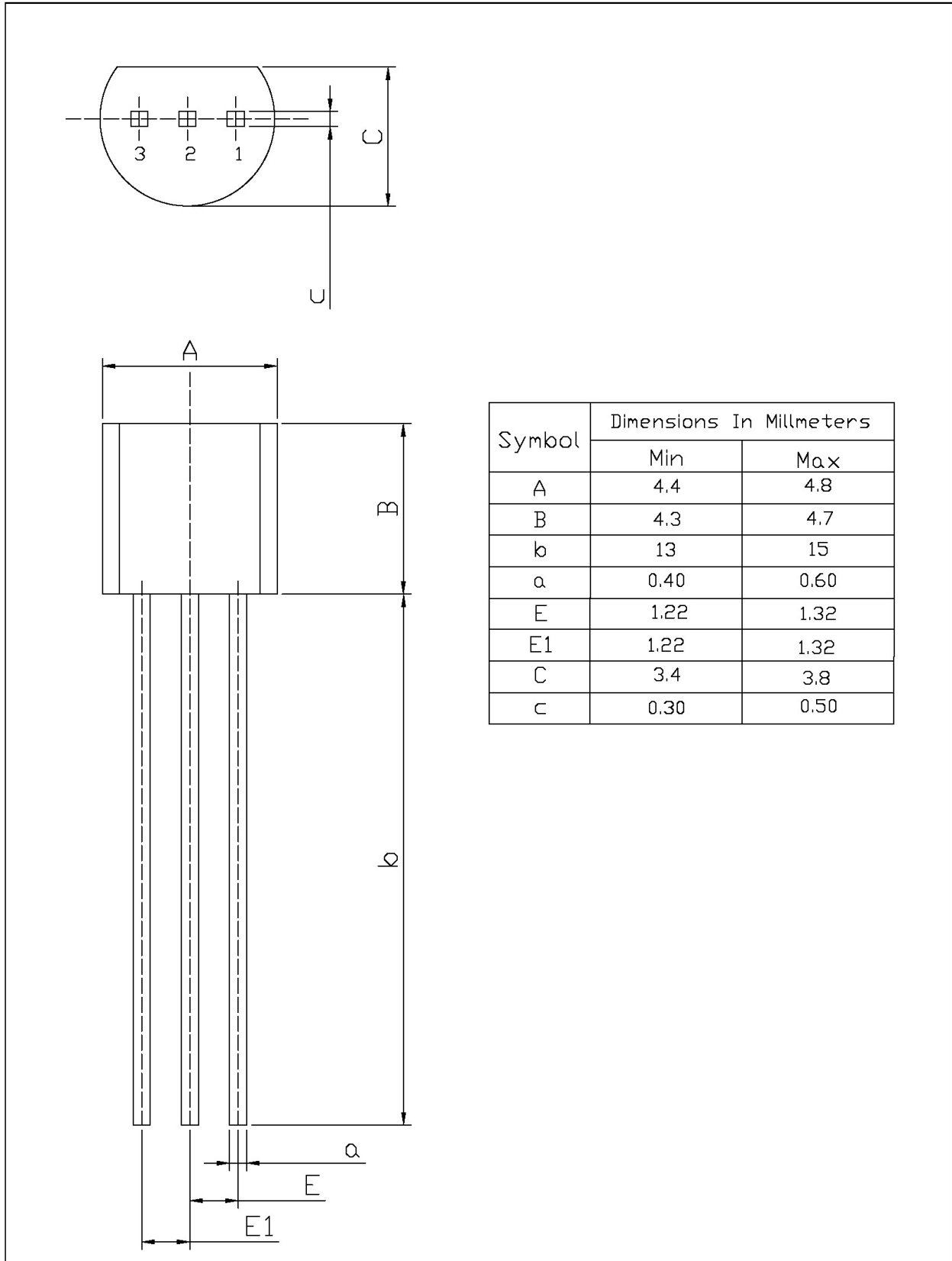

印章说明 / Marking Instructions

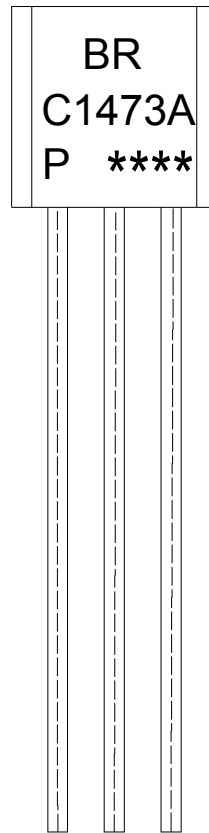

说明：

BR: 为公司代码

C1473A : 为型号代码

P: 为 h_{FE} 分档代码

**** : 为生产批号代码，随生产批号变化。

Note:

BR: Company Code.

C1473A: Product Type.

P: h_{FE} Classifications Symbol

****: Lot No. Code,code change with Lot No.

波峰焊温度曲线图(无铅) / Temperature Profile for Dip Soldering(Pb-Free)



说明：

- 1、预热温度 25 ~ 150°C，时间 60 ~ 90sec;
- 2、峰值温度 255±5°C，时间持续为 5±0.5sec;
- 3、焊接制程冷却速度为 2 ~ 10°C/sec.

Note:

- 1.Preheating:25~150°C, Time:60~90sec.
- 2.Peak Temp.:255±5°C, Duration:5±0.5sec.
3. Cooling Speed: 2~10°C/sec.

耐焊接热试验条件 / Resistance to Soldering Heat Test Conditions

温度：270±5°C

时间：10±1 sec.

Temp:270±5°C

Time:10±1 sec

包装规格 / Packaging SPEC.

散件包装 / BULK

| Package Type 封装形式 | Units 包装数量 | | | | | Dimension 包装尺寸 (unit: mm3) | | |
|----------------------|------------------|-----------------------|------------------------|------------------------------|------------------------|----------------------------|-------------|-------------|
| | Units/Bag 只/袋 | Bags/Inner Box 袋/盒 | Units/Inner Box 只/盒 | Inner Boxes/Outer Box 盒/箱 | Units/Outer Box 只/箱 | Bag 袋 | Inner Box 盒 | Outer Box 箱 |
| TO-92 | 1,000 | 10 | 10,000 | 5 | 50,000 | 135×190 | 237×172×102 | 560×245×195 |
| | 1,000 | 10 | 10,000 | 10 | 100,000 | 135×190 | 237×172×102 | 560×245×375 |

编带包装 / AMMO

| Package Type 封装形式 | Units 包装数量 | | | | | Dimension 包装尺寸 (unit: mm3) | |
|----------------------|--------------------|------------------------|-------------------------|------------------------------|------------------------|----------------------------|-----------------------------------|
| | Units/tape 只/纸带 | Tape/Inner Box 纸带/盒 | Rows/Inner Box 纸带层/盒 | Inner Boxes/Outer Box 盒/箱 | Units/Outer Box 只/箱 | Inner Box 盒 | Outer Box 箱 |
| TO-92 | 3,000 | 1 | 120 | 10 | 30,000 | 328×230×42 | 小箱 480×346×235, 大箱 547×407×268 |

使用说明 / Notices