

BRCS035N06SHBD

Rev.A May.-2024

描述 / Descriptions

TO-263 塑封封装 N 沟道场效应管。
N-CHANNEL MOSFET in a TO-263 Plastic Package.

特征 / Features

$V_{DS}=60V$ $I_D=162A$
 $R_{DS(on)}@10V \leq 3.5m\Omega$ (Type.3.3m Ω)
无卤产品。HF Product.

用途 / Applications

高频开关和同步整流、BMS、电机。
High frequency switching and synchronous rectification, BMS, Motor.

内部等效电路 / Equivalent Circuit

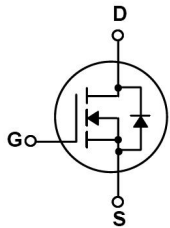

引脚排列 / Pinning

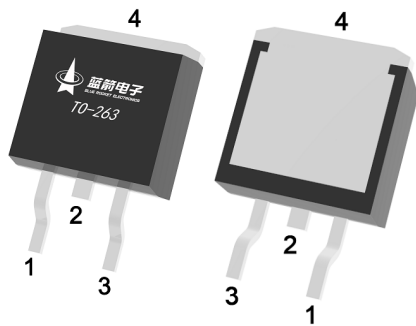

PIN1 : G PIN 2、4 : D PIN 3 : S

印章代码 / Marking

见印章说明。
See Marking Instructions.

极限参数 / Absolute Maximum Ratings(Ta=25°C)

参数 Parameter	符号 Symbol	数值 Rating	单位 Unit
Drain-Source Voltage	V _{DSS}	60	V
Drain Current	I _D (Tc=25°C)	162	A
Pulsed Drain Current	I _{DM}	466	A
Gate-Source Voltage	V _{GS}	±20	V
Single Pulsed Avalanche Energy(L=0.5mH)	E _{AS}	820	mJ
Avalanche Current	I _{AS}	40.5	A
Total Power Dissipation	P _D (Tc=25°C)	170	W
Junction and Storage Temperature Range	T _J , T _{STG}	-55 to 150	°C
Thermal Resistance-Junction to Ambient	t ≤ 10s	23	°C/W
	Steady-State	75	
Thermal Resistance-Junction to Case	Steady-State	0.74	

电性能参数 / Electrical Characteristics(Ta=25°C)

参数 Parameter	符号 Symbol	测试条件 Test Conditions	最小值 Min	典型值 Typ	最大值 Max	单位 Unit
Drain-Source Breakdown Voltage	BV _{DSS}	I _D =250uA, V _{GS} =0V	60	70		V
Zero Gate Voltage Drain Current	I _{DSS}	V _{DS} =60V, V _{GS} =0V			1.0	uA
Gate-Body leakage current	I _{GSS}	V _{DS} =0V, V _{GS} = ±20V			±100	nA
Gate Threshold Voltage	V _{GS(th)}	V _{DS} =V _{GS} , I _D =250uA	2.0		4.0	V
Static Drain-Source On-Resistance	R _{DS(ON)}	V _{GS} =10V, I _D =20A		3.3	3.5	mΩ
Diode Forward Voltage	V _{SD}	I _S =1A, V _{GS} =0V			1.2	V
Input Capacitance	C _{iSS}	V _{DS} =25V V _{GS} =0V f=1.0MHz		4400		pF
Output Capacitance	C _{oSS}			1400		
Reverse Transfer Capacitance	C _{rSS}			73		
Gate resistance	R _g	V _{GS} =0V V _{DS} =0V f=1MHz		1.1		Ω
Total Gate Charge	Q _g	V _{GS} =10V, V _{DS} =30V, I _D =20A		42		nC
Gate Source Charge	Q _{gs}			14		
Gate Drain Charge	Q _{gd}			11		

电性能参数 / Electrical Characteristics(Ta=25°C)

参数 Parameter	符号 Symbol	测试条件 Test Conditions	最小值 Min	典型值 Typ	最大值 Max	单位 Unit
Turn-On Delay Time	$t_{d(on)}$	$V_{GS}=10V$ $V_{DS}=30V$ $R_L=1.5\Omega$ $R_{GEN}=3\Omega$		13		ns
Turn-On Rise Time	t_r			4		
Turn-Off Delay Time	$t_{d(off)}$			47		
Turn-Off Fall Time	t_f			6.5		

电参数曲线图 / Electrical Characteristic Curve

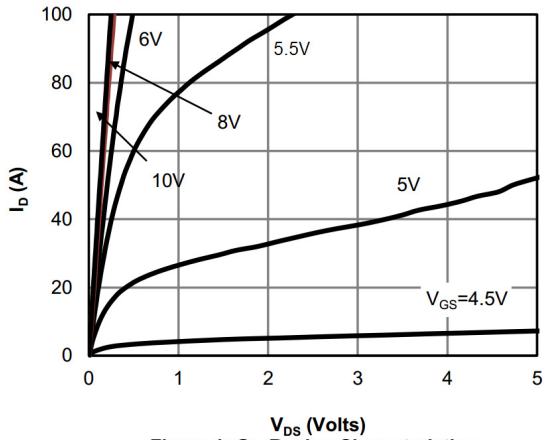

Figure 1: On-Region Characteristics

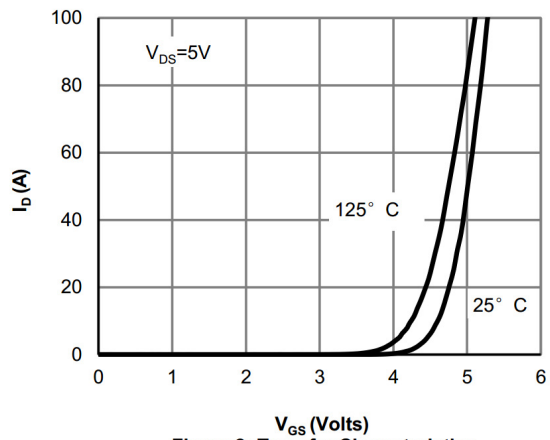

Figure 2: Transfer Characteristics

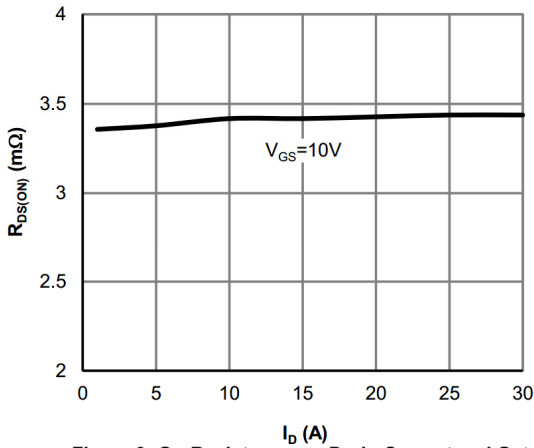

Figure 3: On-Resistance vs. Drain Current and Gate Voltage

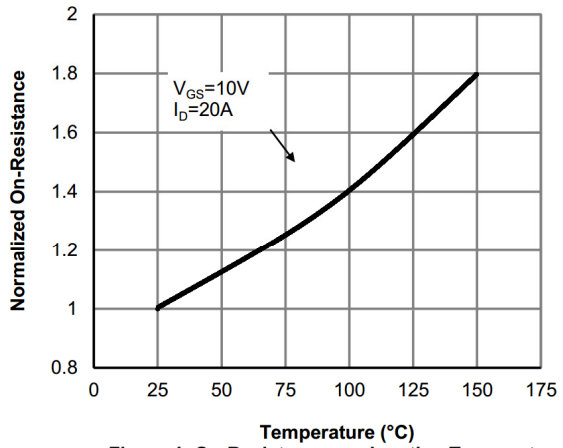

Figure 4: On-Resistance vs. Junction Temperature

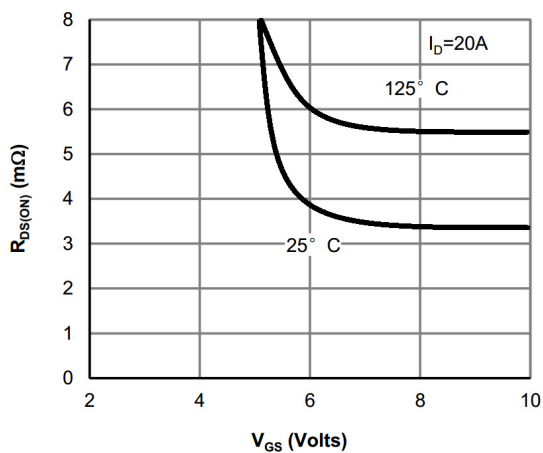

Figure 5: On-Resistance vs. Gate-Source Voltage

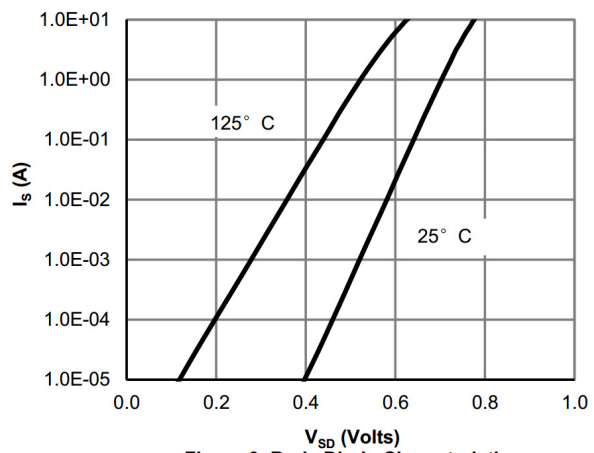

Figure 6: Body-Diode Characteristics

电参数曲线图 / Electrical Characteristic Curve

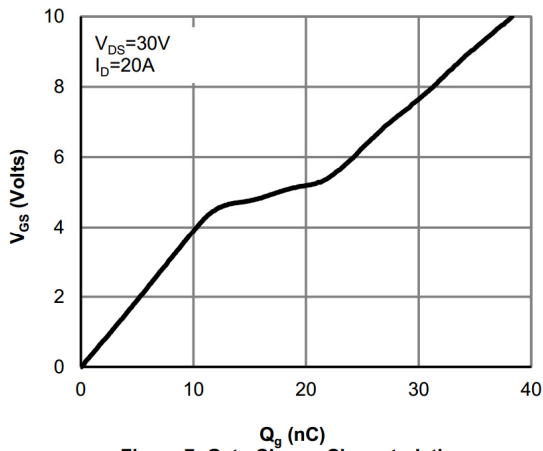

Figure 7: Gate-Charge Characteristics

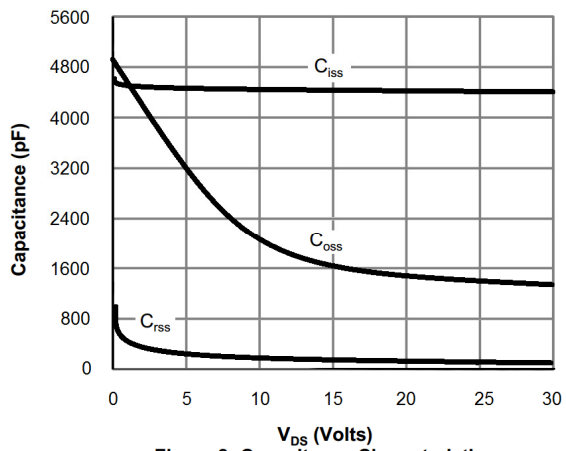

Figure 8: Capacitance Characteristics

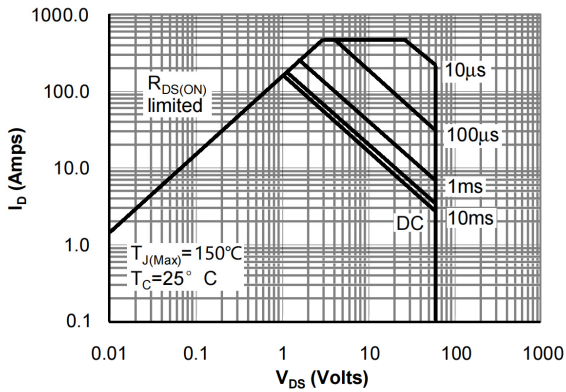

Figure 9: Maximum Forward Biased Safe Operating Area

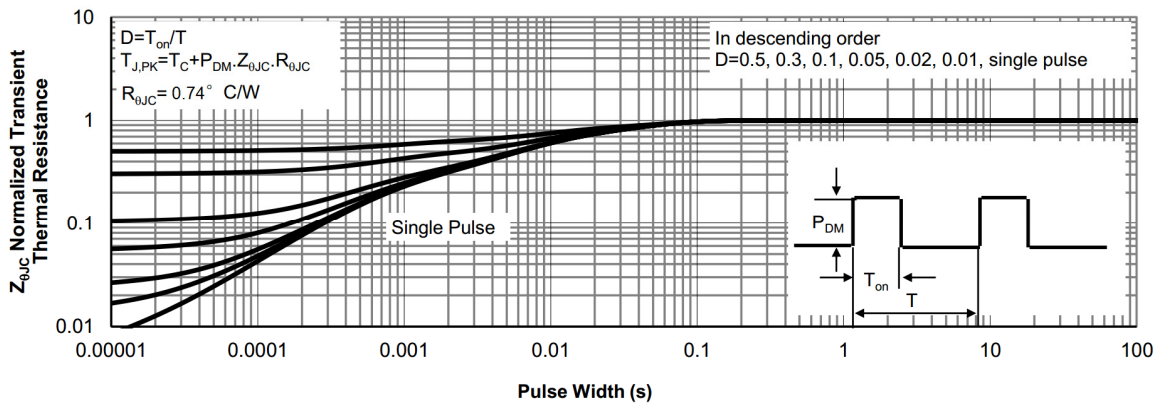
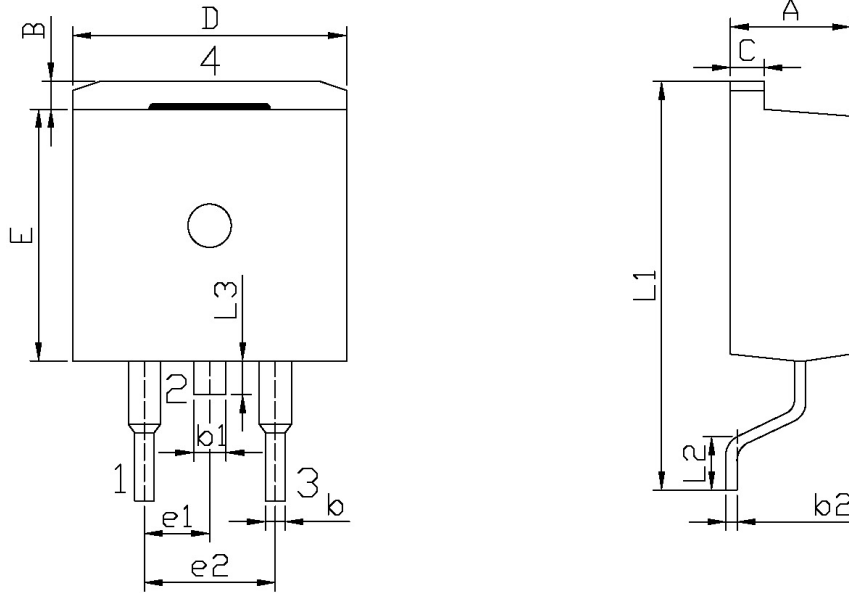

Figure 10: Normalized Maximum Transient Thermal Impedance

外形尺寸图 / Package Dimensions



单位: mm

Symbol	Dimensions In Millimeters		Symbol	Dimensions In Millimeters	
	Min	Max		Min	Max
A	4.30	4.70	E	9.00	9.40
B	1.00	1.40	e1	2.34	2.74
b	0.70	0.90	e2	4.88	5.28
b1	1.15	1.35	L1	15.00	16.00
b2	0.40	0.60	L2	2.24	2.84
C	1.20	1.40	L3	1.20	1.60
D	9.80	10.20			

TQ-263

印章说明 / Marking Instructions

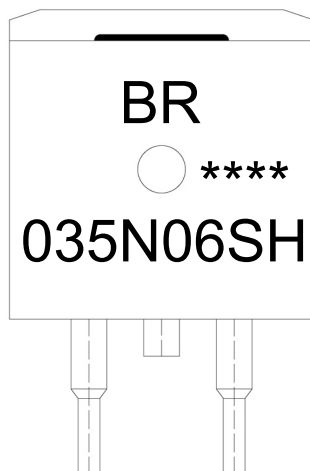

说明：

BR： 为公司代码

035N06SH： 为型号代码

****： 为生产批号代码，随生产批号变化

Note:

BR: Company Code

035N06SH: Product Type Code

****: Lot No. Code, code change with Lot No

回流焊温度曲线图(无铅) / Temperature Profile for IR Reflow Soldering(Pb-Free)



说明：

- 1、预热温度 150~180°C，时间 60~90sec;
- 2、峰值温度 245±5°C，时间持续为 5±0.5sec;
- 3、焊接制程冷却速度为 2~10°C/sec.

Note:

- 1.Preheating:150~180°C, Time:60~90sec.
- 2.Peak Temp.:245±5°C, Duration:5±0.5sec.
3. Cooling Speed: 2~10°C/sec.

耐焊接热试验条件 / Resistance to Soldering Heat Test Conditions

温度：260±5°C

时间：10±1 sec.

Temp.:260±5°C

Time:10±1 sec

包装规格 / Packaging SPEC.

卷盘包装 / REEL

Package Type 封装形式	Units 包装数量					Dimension 包装尺寸 (unit: mm ³)		
	Units/Reel 只/卷盘	Reels/Inner Box 卷盘/盒	Units/Inner Box 只/盒	Inner Boxes/Outer Box 盒/箱	Units/Outer Box 只/箱	Reel	Inner Box 盒	Outer Box 箱
TO-263	800	1	800	6	4,800	13" ×24	360×360×50	380×335×366

套管包装 / TUBE

Package Type 封装形式	Units 包装数量					Dimension 包装尺寸 (unit: mm ³)		
	Units/Tube 只/套管	Tubes/Inner Box 套管/盒	Units/Inner Box 只/盒	Inner Boxes/Outer Box 盒/箱	Units/Outer Box 只/箱	Tube 套管	Inner Box 盒	Outer Box 箱
TO-263	50	20	1,000	5	5,000	532×33×7.0	555×164×50	575×290×180

使用说明 / Notices