

BRCS120N06SRA

Rev.A Apr.-2023

描述 / Descriptions

N 沟道 TO-220 塑封封装场效应管。

N-CHANNEL MOSFET in a TO-220 Plastic Package.

特征 / Features

$R_{DS(on)}$ 小, 门电荷低, C_{rss} 小, 开关速度快, 无卤产品。

Low $R_{DS(on)}$, low gate charge, low C_{rss} , fast switching, HF Product.

用途 / Applications

用于低压电路如: 汽车电路、DC/DC 转换、便携式产品的电源高效转换。

Suited for low voltage applications such as automotive, DC/DC Converters, and high efficiency switching for power management in portable and battery operated products.

内部等效电路 / Equivalent Circuit

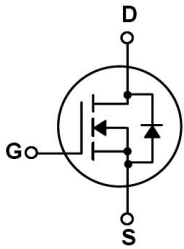

引脚排列 / Pinning

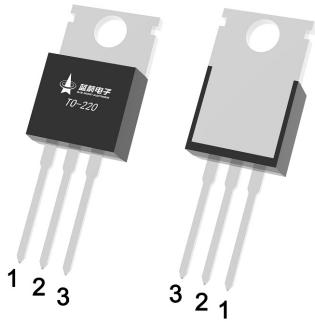

PIN 1 : G

PIN 2 : D

PIN 3 : S

印章代码 / Marking

见印章说明。 See Marking Instructions.

极限参数 / Absolute Maximum Ratings(Ta=25°C)

参数 Parameter	符号 Symbol	数值 Rating	单位 Unit
Drain-Source Voltage	V _{DSS}	60	V
Drain Current	I _D (Tc=25°C)	60	A
Drain Current - Pulsed	I _{DM}	225	A
Gate-Source Voltage	V _{GS}	±20	V
Avalanche Current	I _{AS}	20	A
Single Pulsed Avalanche Energy	E _{AS}	170	mJ
Power Dissipation	P _D (Tc=25°C)	96	W
Storage Temperature Range	T _{stg}	-55~150	°C
Thermal Resistance-Junction to Ambient	t ≤ 10s	15	°C/W
	Steady-State	62	
Thermal Resistance-Junction to Case	Steady-State	1.3	

电性能参数 / Electrical Characteristics(Ta=25°C)

参数 Parameter	符号 Symbol	测试条件 Test Conditions	最小值 Min	典型值 Typ	最大值 Max	单位 Unit
Drain-Source Breakdown Voltage	BV _{DSS}	V _{GS} =0V I _D =250μA	60	63		V
Zero Gate Voltage Drain Current	I _{DSS}	V _{DS} =60V V _{GS} =0V			1.0	μA
		V _{DS} =48V T _C =150°C			10	
Gate-Body Leakage Current Forward	I _{GSS}	V _{GS} =±20V V _{DS} =0V			±0.1	μA
Gate Threshold Voltage	V _{GS(th)}	V _{DS} =V _{GS} I _D =250μA	1	1.6	3	V
Static Drain-Source On-Resistance	R _{DS(on)}	V _{GS} =10V I _D =25A		10.5	15	mΩ
		V _{GS} =4.5V I _D =18A		13.5	20	
Drain-Source Diode Forward Voltage	V _{SD}	V _{GS} =0V I _S =25A			1.25	V
Gate resistance	R _g	V _{GS} =0V V _{DS} =0V, f=1MHz		1.49		Ω
Input Capacitance	C _{iss}	V _{DS} =25V V _{GS} =0V f=1.0MHz		1010		pF
Output Capacitance	C _{oss}			250		
Reverse Transfer Capacitance	C _{rss}			280		
Total Gate Charge	Q _g (10V)	V _{GS} =10V V _{DS} =30V I _D =20A		22		nC
Total Gate Charge	Q _g (4.5V)			8.7		
Gate Source Charge	Q _{gs}			5.5		
Gate Drain Charge	Q _{gd}			2.6		

电性能参数 / Electrical Characteristics(Ta=25°C)

参数 Parameter	符号 Symbol	测试条件 Test Conditions	最小值 Min	典型值 Typ	最大值 Max	单位 Unit
Turn-On Delay Time	$t_{d(on)}$	$V_{GS}=10V$ $V_{DS}=30V$ $R_L=1.5\Omega$ $R_{GEN}=3\Omega$		8.9		ns
Turn-On Rise Time	t_r			3.7		
Turn-Off Delay Time	$t_{d(off)}$			25		
Turn-Off Fall Time	t_f			3.5		

电参数曲线图 / Electrical Characteristic Curve

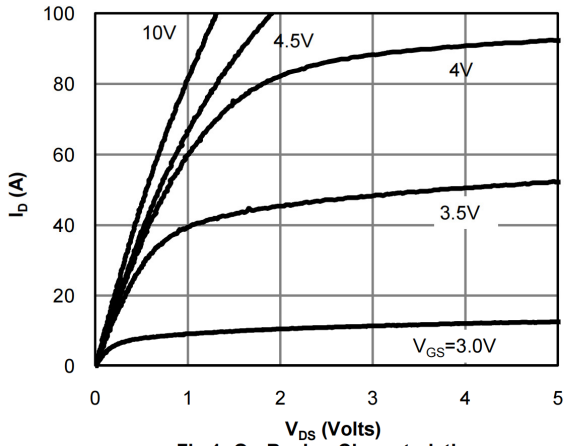

Fig 1: On-Region Characteristics

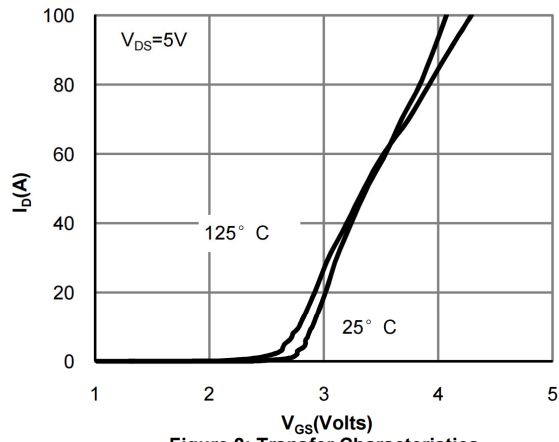

Figure 2: Transfer Characteristics

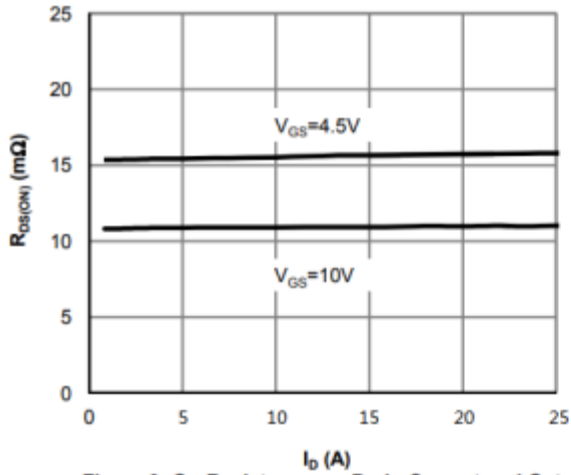

Figure 3: On-Resistance vs. Drain Current and Gate Voltage

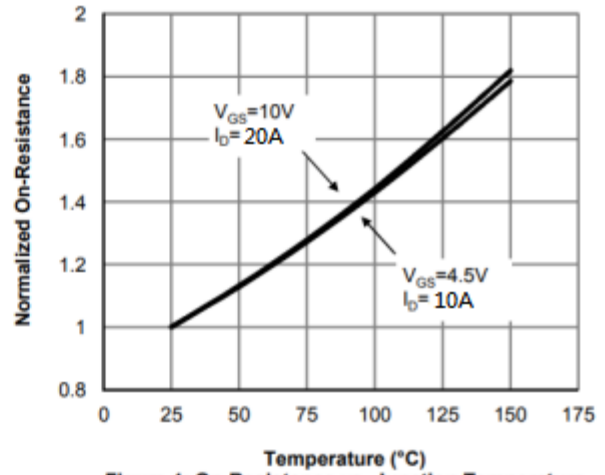

Figure 4: On-Resistance vs. Junction Temperature

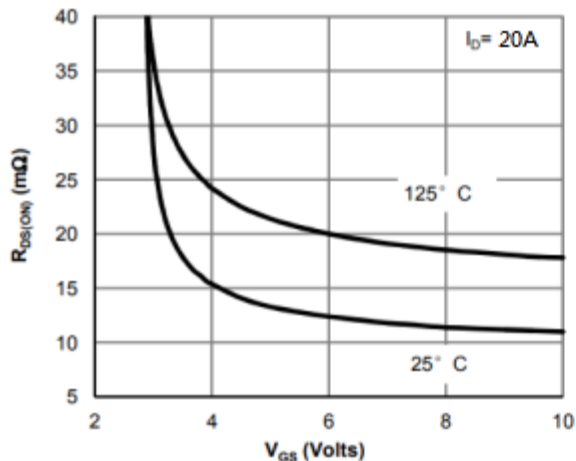

Figure 5: On-Resistance vs. Gate-Source Voltage

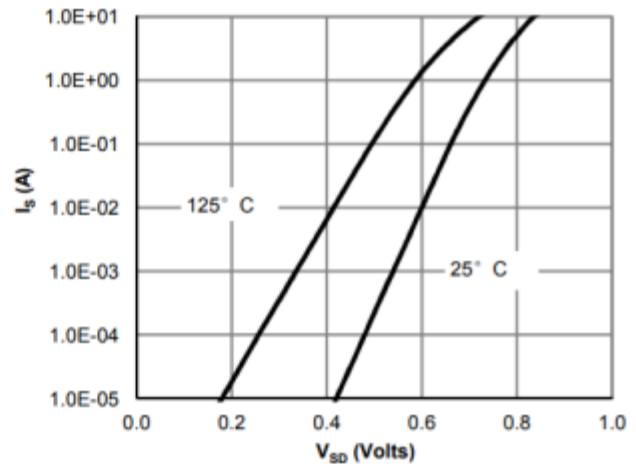

Figure 6: Body-Diode Characteristics

电参数曲线图 / Electrical Characteristic Curve

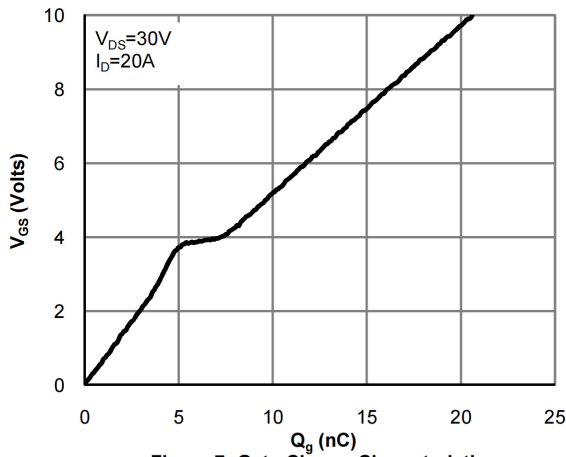

Figure 7: Gate-Charge Characteristics

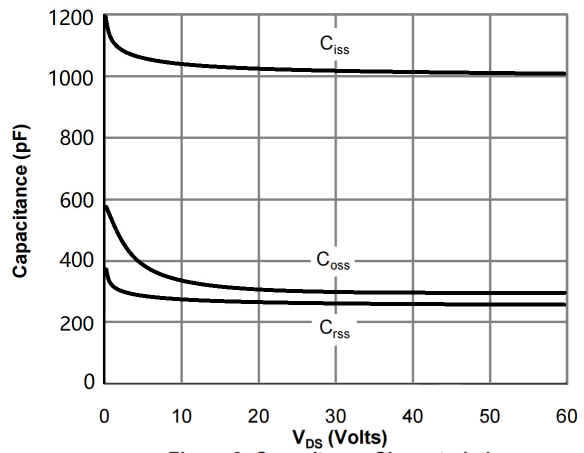

Figure 8: Capacitance Characteristics

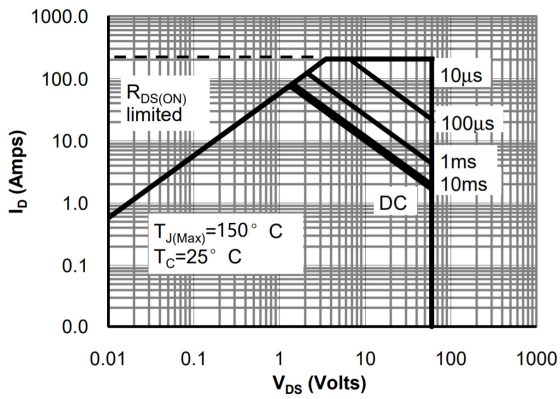

Figure 9: Maximum Forward Biased Safe Operating Area

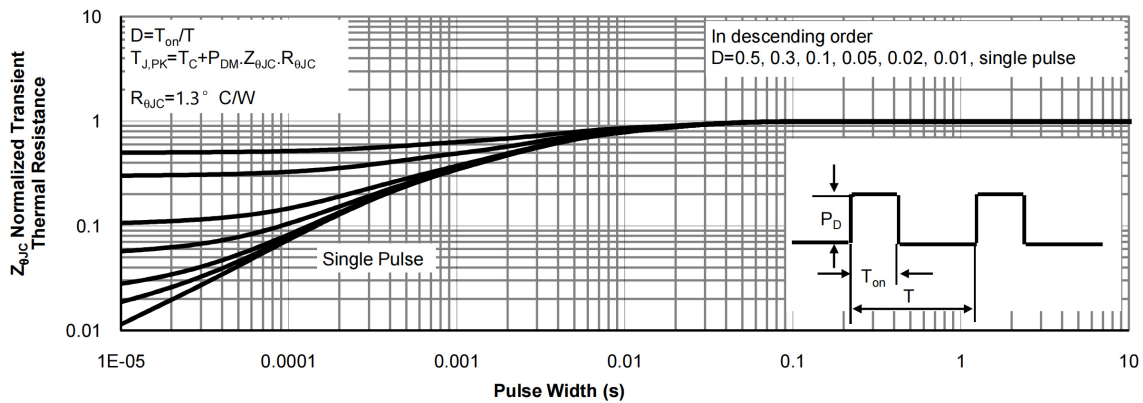
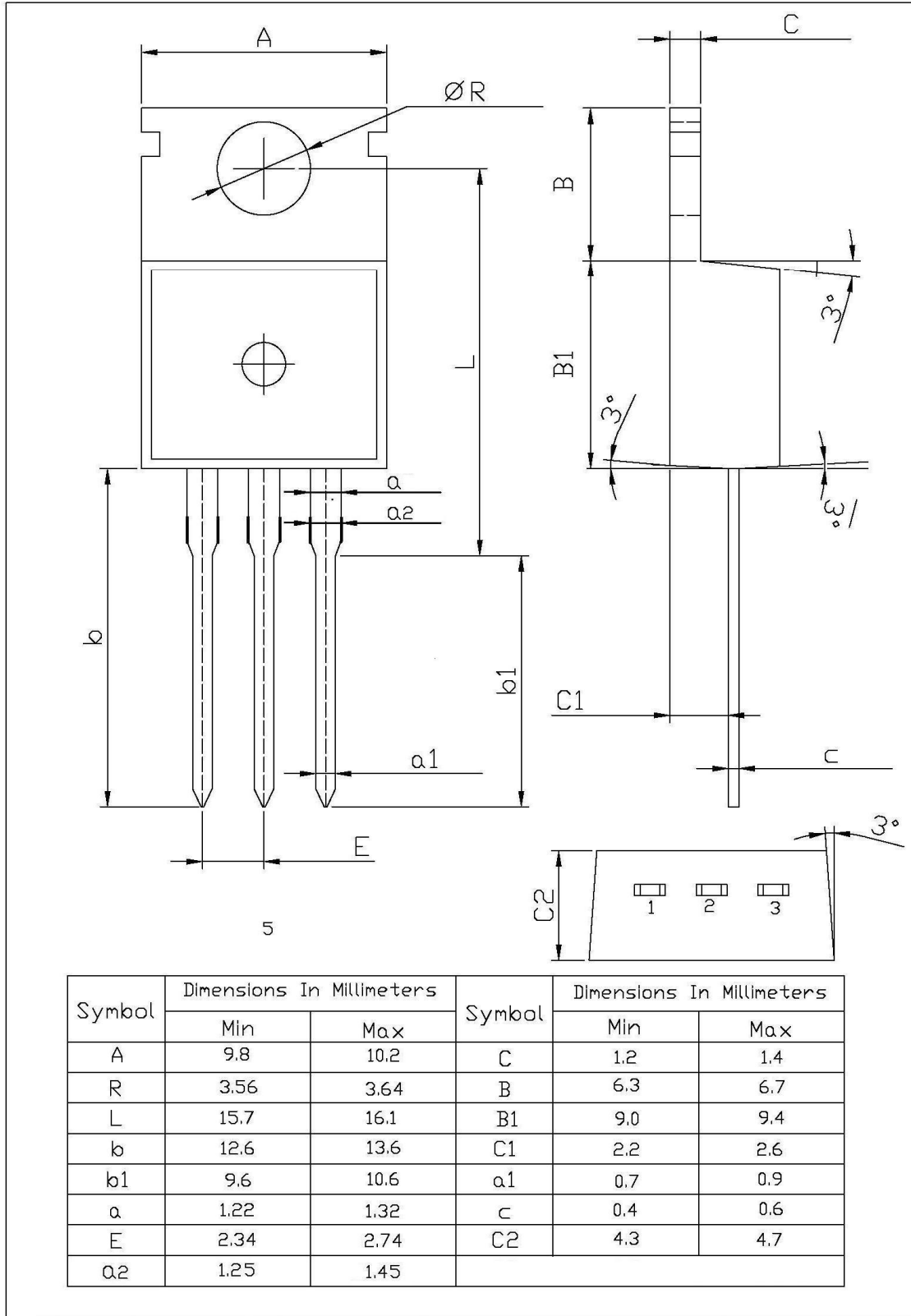

Figure 10: Normalized Maximum Transient Thermal Impedance

外形尺寸图 / Package Dimensions

TO-220

单位: mm



印章说明 / Marking Instructions

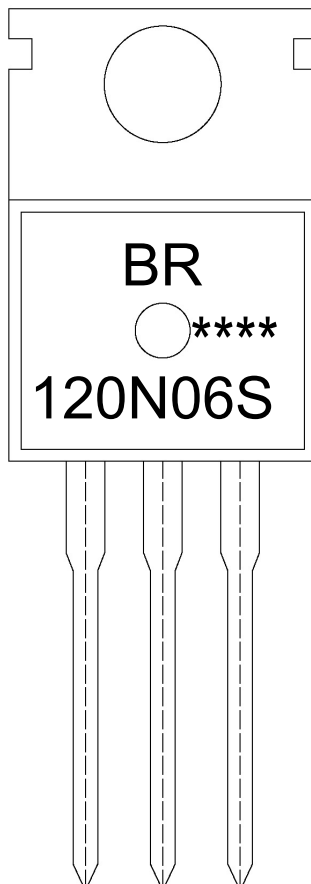

说明：

BR： 为公司代码

120N06S： 为型号代码

****： 为生产批号代码，随生产批号变化

Note:

BR: Company Code

120N06S: Product Type

****: Lot No. Code, code change with Lot No

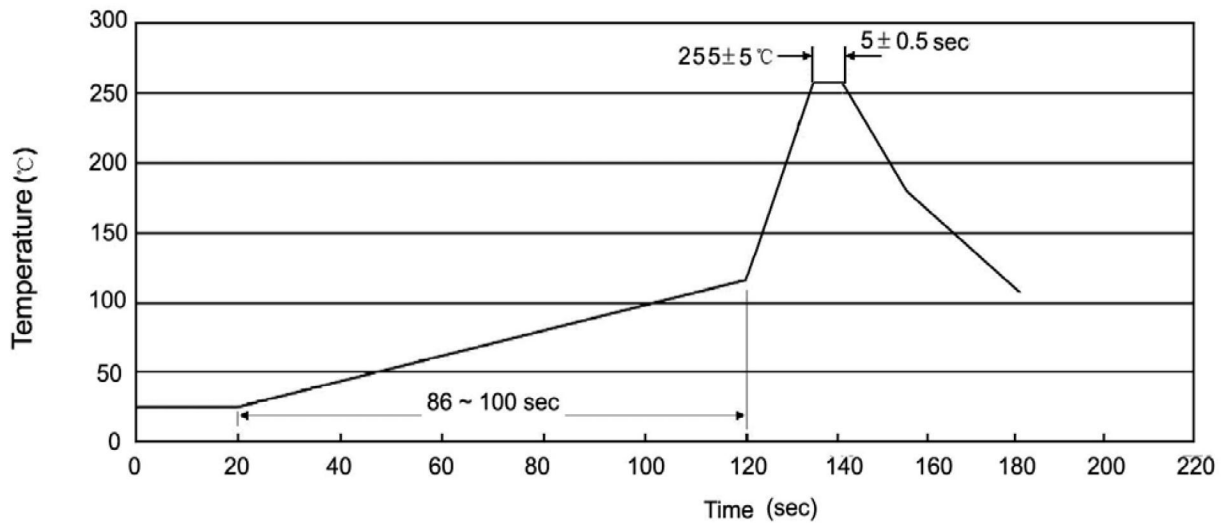
波峰焊温度曲线图(无铅) / Temperature Profile for Dip Soldering(Pb-Free)

说明：

- 1、预热温度 25 ~ 150°C，时间 60 ~ 90sec；
- 2、峰值温度 255±5°C，时间持续为 5±0.5sec；
- 3、焊接制程冷却速度为 2 ~ 10°C/sec.

Note:

- 1.Preheating:25~150°C, Time:60~90sec.
- 2.Peak Temp.:255±5°C, Duration:5±0.5sec.
3. Cooling Speed: 2~10°C/sec.

耐焊接热试验条件 / Resistance to Soldering Heat Test Conditions

温度：270±5°C

时间：10±1 sec.

Temp.:270±5°C

Time:10±1 sec

包装规格 / Packaging SPEC.

散件包装 / BULK

Package Type 封装形式	Units 包装数量					Dimension 包装尺寸 (unit: mm ³)		
	Units/Bag 只/袋	Bags/Inner Box 袋/盒	Units/Inner Box 只/盒	Inner Boxes/Outer Box 盒/箱	Units/Outer Box 只/箱	Bag 袋	Inner Box 盒	Outer Box 箱
TO-220/F	200	10	2,000	5	10,000	135×190	237×172×102	560×245×195

套管包装 / TUBE

Package Type 封装形式	Units 包装数量					Dimension 包装尺寸 (unit: mm ³)		
	Units/Tube 只/套管	Tubes/Inner Box 套管/盒	Units/Inner Box 只/盒	Inner Boxes/Outer Box 盒/箱	Units/Outer Box 只/箱	Tube 套管	Inner Box 盒	Outer Box 箱
TO-220/F	50	20	1,000	5	5,000	532×31.4×5.5	555×164×50	575×290×180

使用说明 / Notices