

# BRFL65R280C

Rev.A Jul.-2023

## 描述 / Descriptions

TO-220FL 塑封封装 N 沟道 650V 超结工艺功率场效应管。

N-CHANNEL 650V Super-Junction Power MOSFET in a TO-220FL Plastic Package.

## 特征 / Features

低  $R_{DS(on)} \times Q_g$  , 100%雪崩测试, 符合 ROHS 标准。

Very low  $R_{DS(on)} \times Q_g$ , 100%avalanche tested, RoHS compliant.

## 用途 / Applications

用于开关电源, 不间断电源, 功率因素校正。

For switch mode power supply, uninterruptible power supply, power factor correction.

## 内部等效电路 / Equivalent Circuit

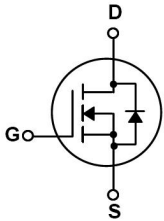

## 引脚排列 / Pinning

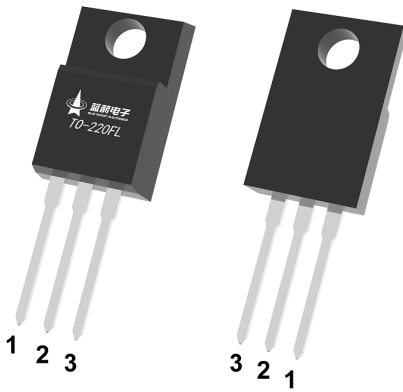

PIN1 : G

PIN 2 : D

PIN 3 : S

## 印章代码 / Marking

见印章说明。 See Marking Instructions.

**极限参数 / Absolute Maximum Ratings(Ta=25°C)**

参数 Parameter	符号 Symbol	数值 Rating	单位 Unit
Drain-Source Voltage	V <sub>DSS</sub>	650	V
Drain Current	I <sub>D</sub> (Tc=25°C)	14	A
Drain Current - Pulsed	I <sub>DM</sub>	56	A
Gate-Source Voltage	V <sub>GS</sub>	±30	V
Single Pulsed Avalanche Energy	E <sub>AS</sub>	433	mJ
Avalanche Current	I <sub>AS</sub>	10	A
Power Dissipation	P <sub>D</sub> (Tc=25°C)	30	W
Operating and Storage Temperature Range	T <sub>J</sub> , T <sub>STG</sub>	-55 to 150	°C
Junction-to-Case	R <sub>θJC</sub>	4.2	°C/W
Junction-to-Ambient	R <sub>θJA</sub>	65	°C/W

**电性能参数 / Electrical Characteristics(Ta=25°C)**

参数 Parameter	符号 Symbol	测试条件 Test Conditions	最小值 Min	典型值 Typ	最大值 Max	单位 Unit
Drain-Source Breakdown Voltage	BV <sub>DSS</sub>	V <sub>GS</sub> =0V I <sub>D</sub> =250μA	650	700		V
Zero Gate Voltage Drain Current	I <sub>DSS</sub>	V <sub>DS</sub> =650V V <sub>GS</sub> =0V T <sub>J</sub> =25°C			1.0	μA
Gate-Body Leakage Current, Forward	I <sub>GSS</sub>	V <sub>GS</sub> =±30V			±100	nA
Gate Threshold Voltage	V <sub>GS(th)</sub>	V <sub>DS</sub> =V <sub>GS</sub> I <sub>D</sub> =250μA	2.5	3.3	4.5	V
Static Drain-Source On-Resistance	R <sub>DS(on)</sub>	V <sub>GS</sub> =10V I <sub>D</sub> =5.5A		235	280	mΩ
Drain-Source Diode Forward Voltage	V <sub>SD</sub>	V <sub>GS</sub> =0V I <sub>SD</sub> =1A T <sub>J</sub> =25°C			1.2	V
Gate Resistance	R <sub>g</sub>	V <sub>GS</sub> = 0V f = 1.0MHz		3.7		Ω
Input Capacitance	C <sub>iss</sub>	V <sub>DS</sub> =100V V <sub>GS</sub> =0V f=1.0MHz		995		pF
Output Capacitance	C <sub>oss</sub>			50		pF
Reverse Transfer Capacitance	C <sub>rss</sub>			0.87		pF
Turn-On Delay Time	t <sub>d(on)</sub>	V <sub>DS</sub> =400V I <sub>D</sub> =7.5A R <sub>G</sub> =25Ω V <sub>GS</sub> =10V		20		ns
Turn-On Rise Time	t <sub>r</sub>			40		ns
Turn-Off Delay Time	t <sub>d(off)</sub>			95		ns
Turn-Off Fall Time	t <sub>f</sub>			43		ns

## 电性能参数 / Electrical Characteristics(Ta=25°C)

参数 Parameter	符号 Symbol	测试条件 Test Conditions	最小值 Min	典型值 Typ	最大值 Max	单位 Unit
Continuous Diode Forward Current	$I_S$				14	A
Total Gate Charge	$Q_g$	$V_{DS}=520V$ $I_D=7.5A$ $V_{GS}=10V$		26		nC
Gate-Source Charge	$Q_{gs}$			3.6		nC
Gate-Drain Charge	$Q_{gd}$			10.5		nC
Reverse recovery time	$t_{rr}$	$V_R=400V$ , $I_F=7.5A$ , $di_F/dt=100A/\mu s$		405		ns
Reverse recovery charge	$Q_{rr}$			4.0		uC

电参数曲线图 / Electrical Characteristic Curve

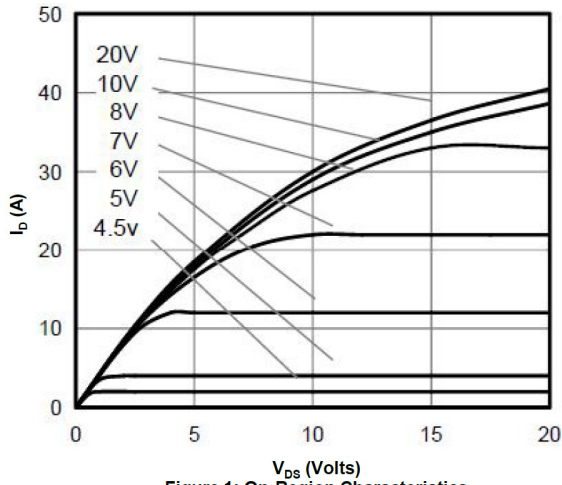

Figure 1: On-Region Characteristics

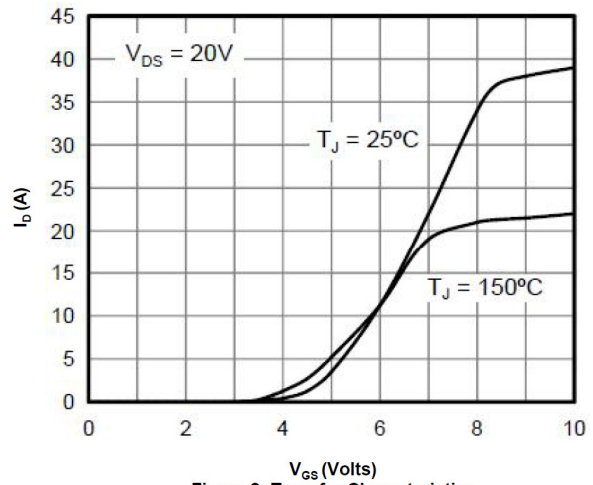

Figure 2: Transfer Characteristics

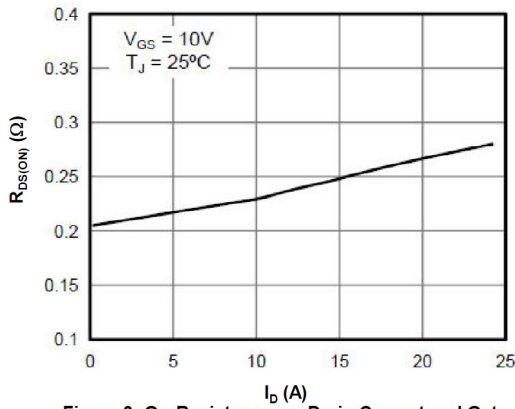

Figure 3: On-Resistance vs. Drain Current and Gate Voltage

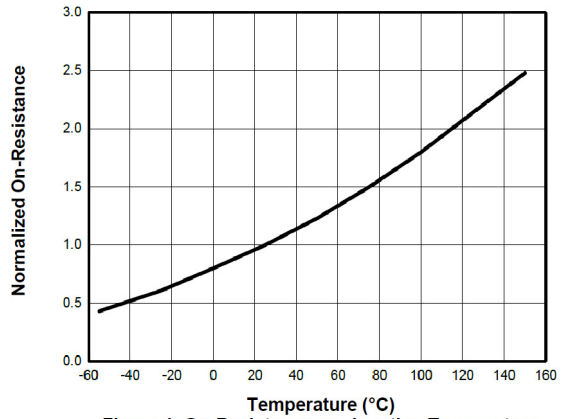

Figure 4: On-Resistance vs. Junction Temperature

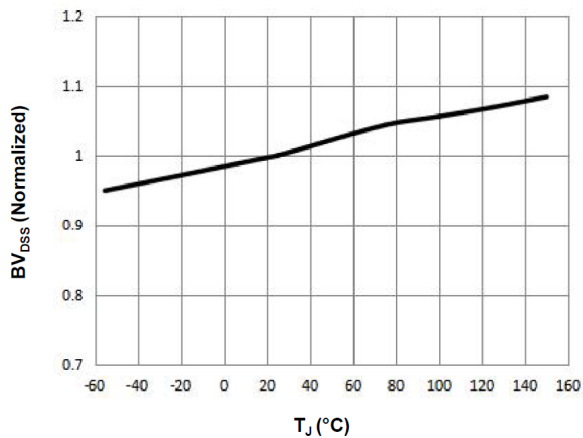

Figure 5: Break Down vs. Junction Temperature

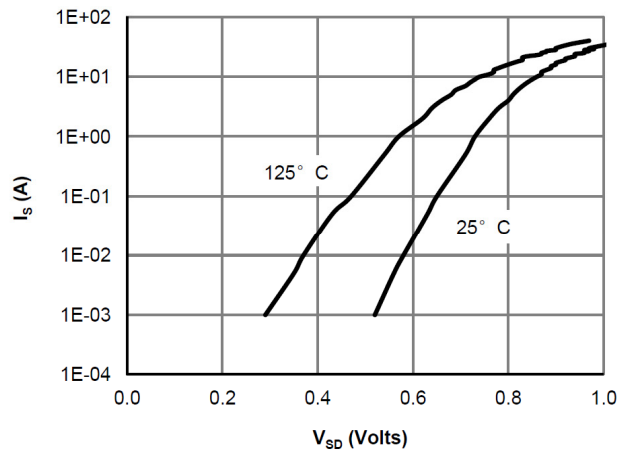

Figure 6: Body-Diode Characteristics

## 电参数曲线图 / Electrical Characteristic Curve

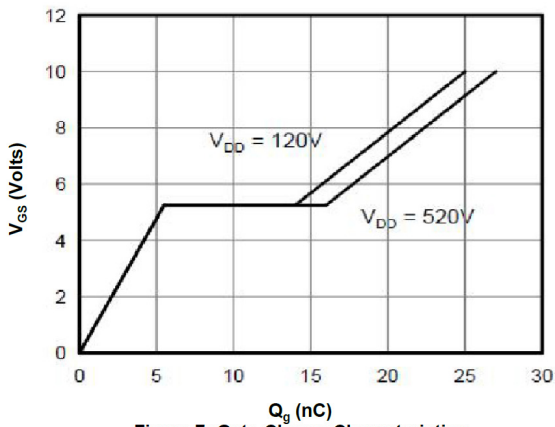

Figure 7: Gate-Charge Characteristics

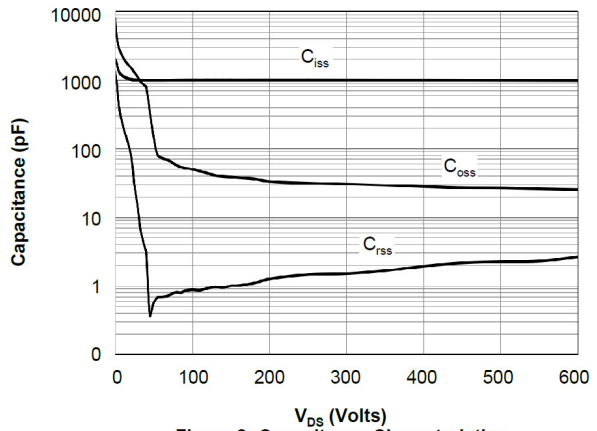

Figure 8: Capacitance Characteristics

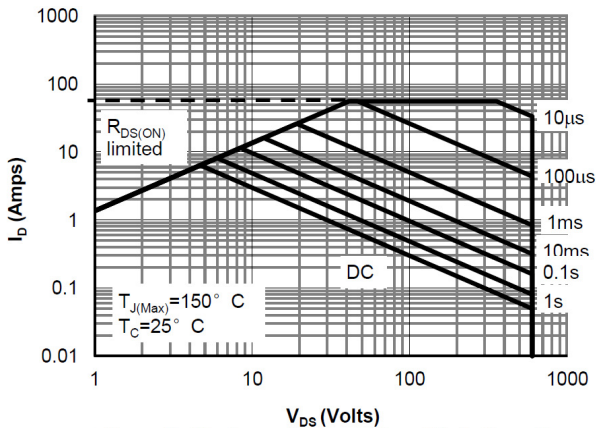

Figure 9: Maximum Forward Biased Safe Operating Area

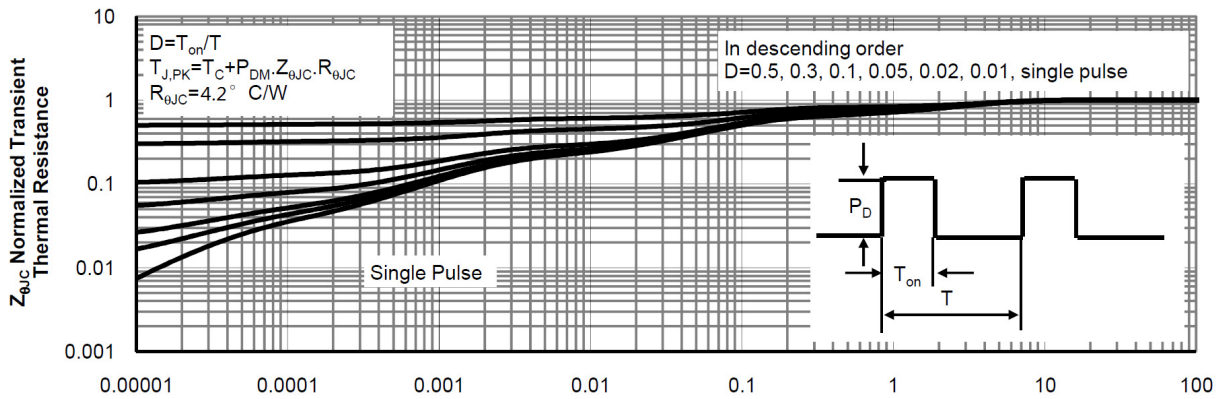
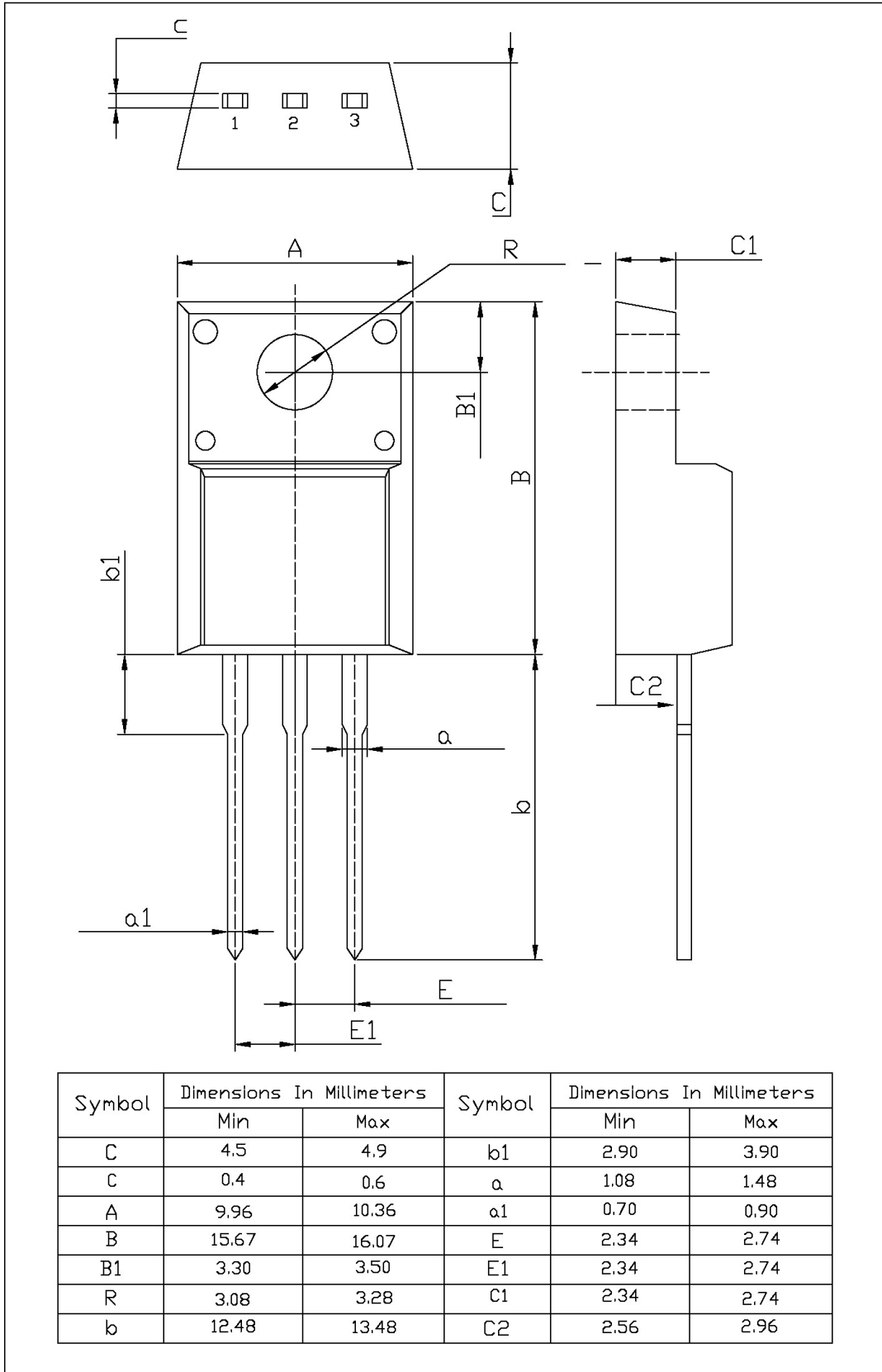

Figure 10: Normalized Maximum Transient Thermal Impedance

外形尺寸图 / Package Dimensions

TO-220FL

单位: mm



## 印章说明 / Marking Instructions

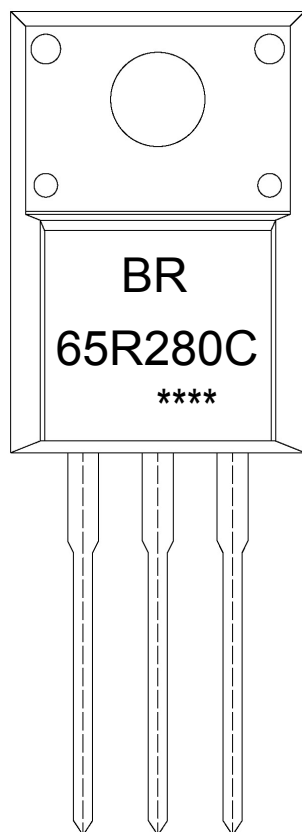

说明：

BR： 为公司代码

65R280C： 为型号代码

\*\*\*\*： 为生产批号代码，随生产批号变化

Note:

BR: Company Code

65R280C: Product Type

\*\*\*\*: Lot No. Code, code change with Lot No

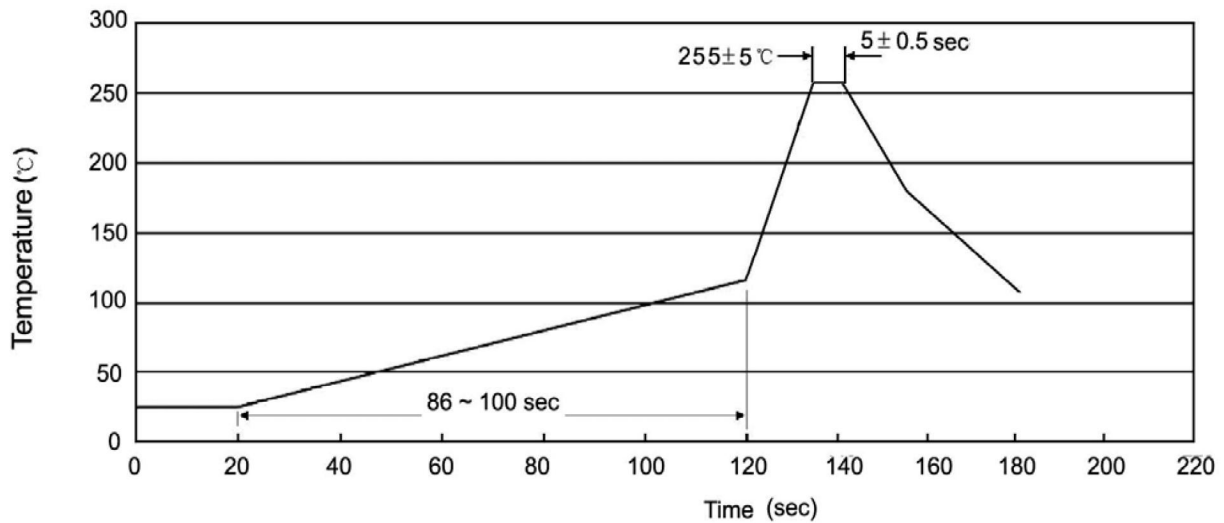
**波峰焊温度曲线图(无铅) / Temperature Profile for Dip Soldering(Pb-Free)**

说明：

- 1、预热温度 25 ~ 150°C，时间 60 ~ 90sec；
- 2、峰值温度 255±5°C，时间持续为 5±0.5sec；
- 3、焊接制程冷却速度为 2 ~ 10°C/sec.

Note:

- 1.Preheating:25~150°C, Time:60~90sec.
- 2.Peak Temp.:255±5°C, Duration:5±0.5sec.
3. Cooling Speed: 2~10°C/sec.

**耐焊接热试验条件 / Resistance to Soldering Heat Test Conditions**

温度：270±5°C

时间：10±1 sec.

Temp.:270±5°C

Time:10±1 sec

**包装规格 / Packaging SPEC.**

套管包装 / TUBE

Package Type 封装形式	Units 包装数量					Dimension 包装尺寸 (unit: mm <sup>3</sup> )		
	Units/Tube 只/套管	Tubes/Inner Box 套管/盒	Units/Inner Box 只/盒	Inner Boxes/Outer Box 盒/箱	Units/Outer Box 只/箱	Tube 套管	Inner Box 盒	Outer Box 箱
TO-220FL	50	20	1,000	5	5,000	532×33×7.0	555×164×50	575×290×180

**使用说明 / Notices**