

## 描述 / Descriptions

TO-92 塑封封装 NPN 半导体三极管。Silicon NPN transistor in a TO-92 Plastic Package.

## 特征 / Features

放大线性好，与 KTA1270 互补。

Excellent  $h_{FE}$  linearity, complementary to KTA1270.

## 用途 / Applications

用于一般放大和开关电路。

General purpose and switching application.

## 内部等效电路 / Equivalent Circuit

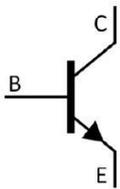

## 引脚排列 / Pinning



PIN 1 : Base      PIN 2 : Collector      PIN 3 : Emitter

## 放大及印章代码 / $h_{FE}$ Classifications & Marking

$h_{FE}$ Classifications Symbol	O	Y
$h_{FE}$ Range	70~140	120~240

**极限参数 / Absolute Maximum Ratings(Ta=25°C)**

参数 Parameter	符号 Symbol	数值 Rating	单位 Unit
Collector to Base Voltage	$V_{CBO}$	35	V
Collector to Emitter Voltage	$V_{CEO}$	30	V
Emitter to Base Voltage	$V_{EBO}$	5.0	V
Collector Current - Continuous	$I_C$	500	mA
Emitter Current - Continuous	$I_E$	-500	mA
Collector Power Dissipation	$P_C$	625	mW
Junction Temperature	$T_j$	150	°C
Storage Temperature Range	$T_{stg}$	-55~150	°C

**电性能参数 / Electrical Characteristics(Ta=25°C)**

参数 Parameter	符号 Symbol	测试条件 Test Conditions	最小值 Min	典型值 Typ	最大值 Max	单位 Unit
Collector Cut-Off Current	$I_{CBO}$	$V_{CB}=35V$ $I_E=0$			0.1	$\mu A$
Emitter Cut-Off Current	$I_{EBO}$	$V_{EB}=5.0V$ $I_C=0$			0.1	$\mu A$
DC Current Gain	$h_{FE(1)}$	$V_{CE}=1.0V$ $I_C=100mA$	70		240	
	$h_{FE(2)}$	$V_{CE}=6.0V$ $I_C=400mA$	25			
Collector to Emitter Saturation Voltage	$V_{CE(sat)}$	$I_C=100mA$ $I_B=10mA$		0.1	0.25	V
Base to Emitter Voltage	$V_{BE}$	$V_{CE}=1.0V$ $I_C=100mA$		0.8	1.0	V
Transition Frequency	$f_T$	$V_{CE}=6.0V$ $I_C=20mA$		300		MHz
Collector Capacitance	$C_{ob}$	$V_{CB}=6.0V$ $I_E=0$ $f=1.0MHz$		7.0		pF

**电参数曲线图 / Electrical Characteristic Curve**

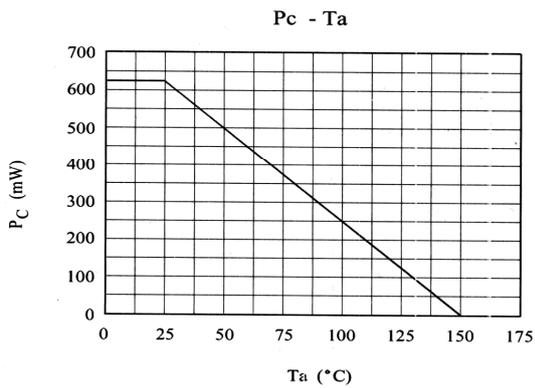
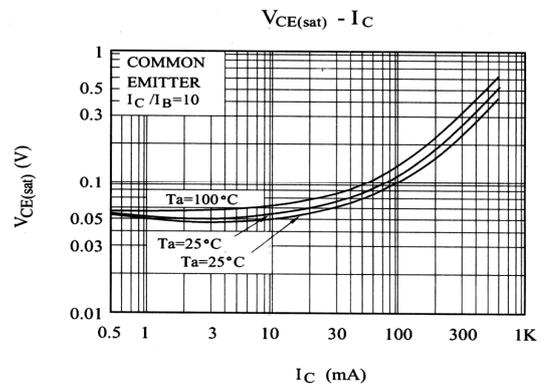
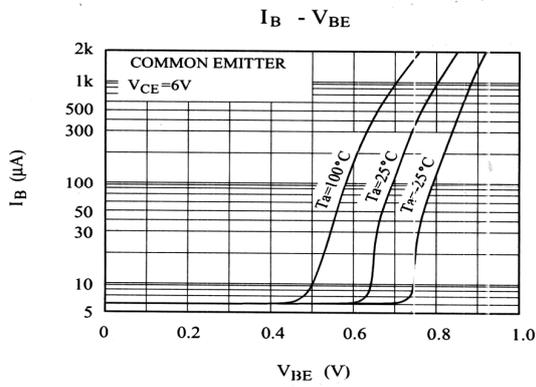
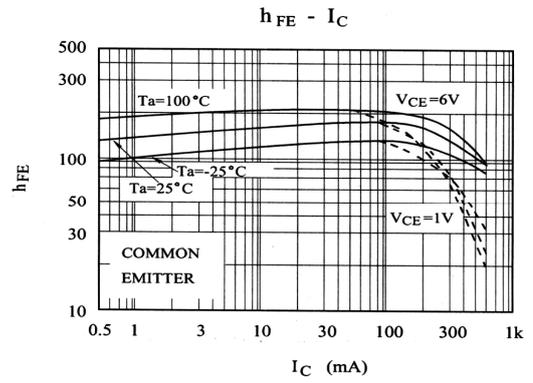
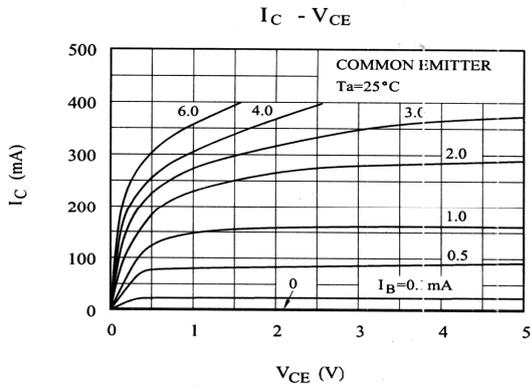

外形尺寸图 / Package Dimensions

T0-92

Unit: mm

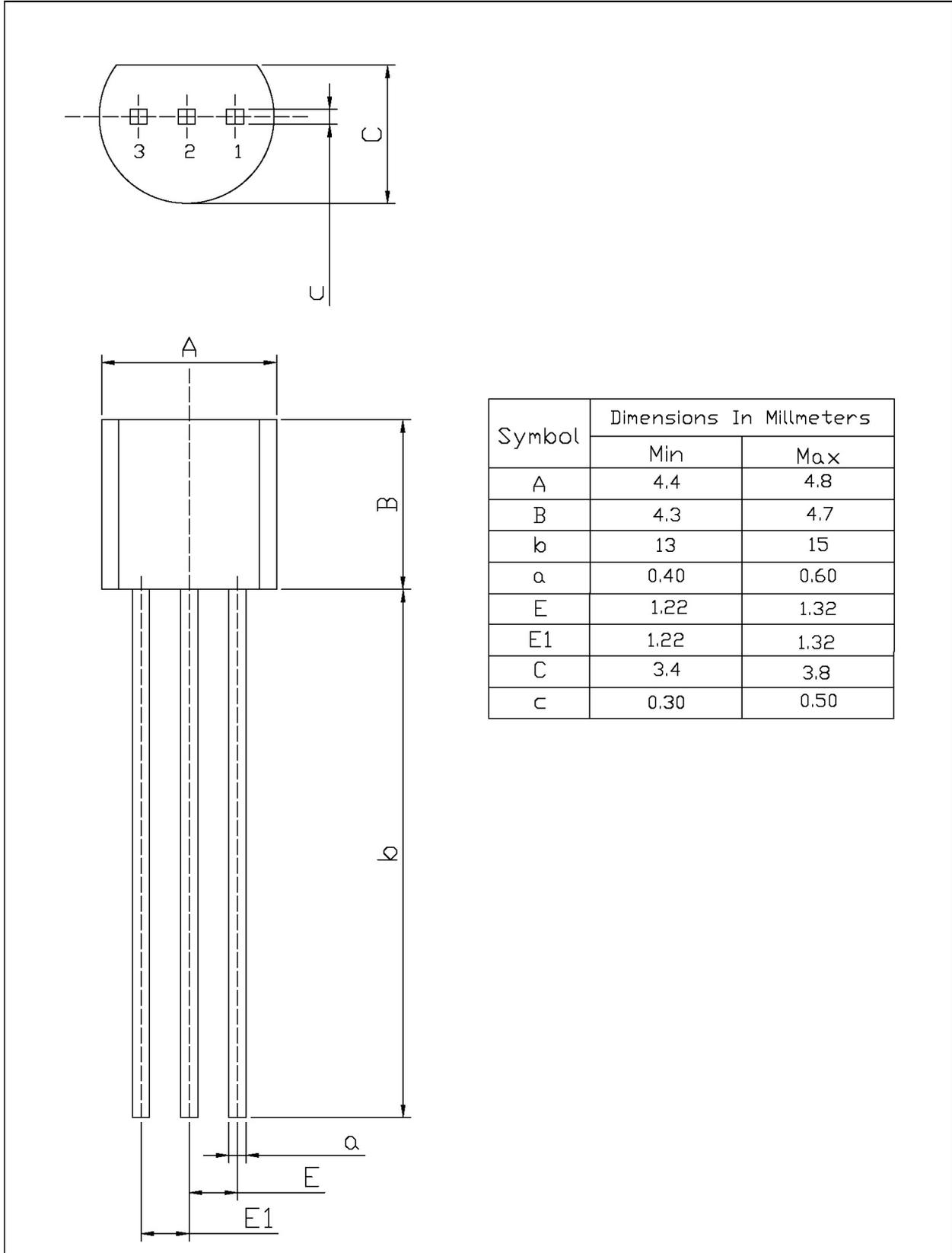

Symbol	Dimensions In Millimeters	
	Min	Max
A	4.4	4.8
B	4.3	4.7
b	13	15
a	0.40	0.60
E	1.22	1.32
E1	1.22	1.32
C	3.4	3.8
c	0.30	0.50

印章说明 / Marking Instructions

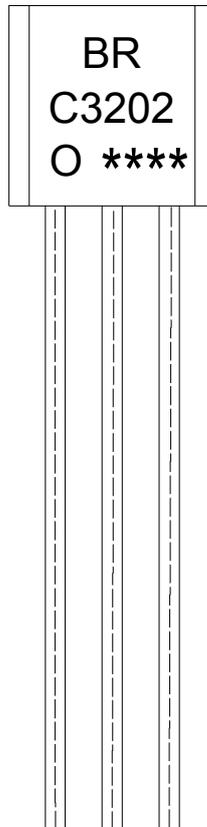

说明：

BR: 为公司代码

C3202 : 为型号代码

O: 为  $h_{FE}$  分档代码

\*\*\*\* : 为生产批号代码，随生产批号变化。

Note:

BR: Company Code.

C3202: Product Type.

O:  $h_{FE}$  Classifications Symbol

\*\*\*\*: Lot No. Code,code change with Lot No.

**波峰焊温度曲线图(无铅) / Temperature Profile for Dip Soldering(Pb-Free)**

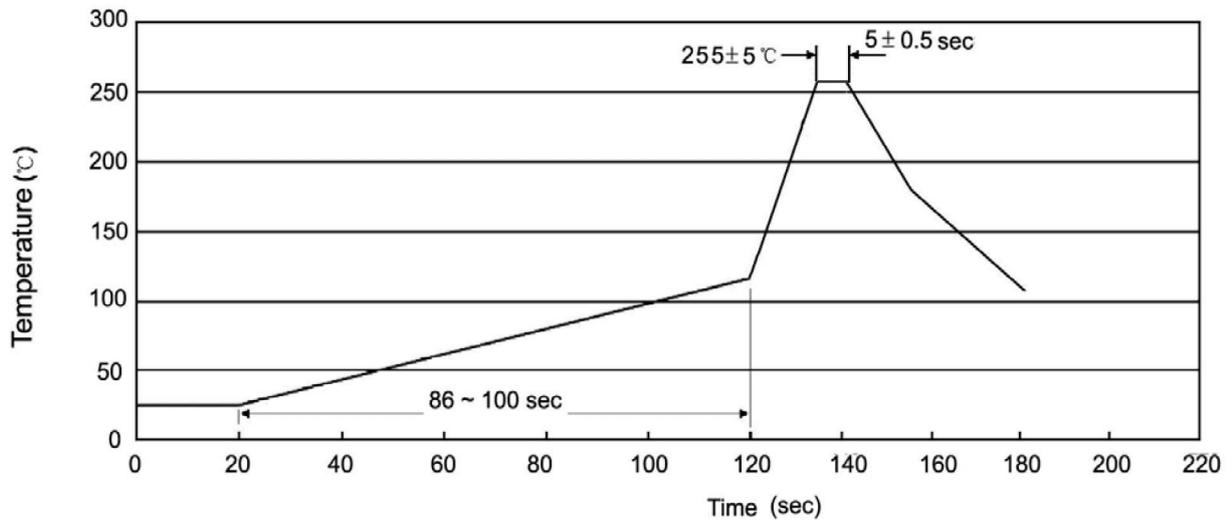

说明：

- 1、预热温度 25 ~ 150°C，时间 60 ~ 90sec;
- 2、峰值温度 255±5°C，时间持续为 5±0.5sec;
- 3、焊接制程冷却速度为 2 ~ 10°C/sec.

Note:

- 1.Preheating:25~150°C, Time:60~90sec.
- 2.Peak Temp.:255±5°C, Duration:5±0.5sec.
3. Cooling Speed: 2~10°C/sec.

**耐焊接热试验条件 / Resistance to Soldering Heat Test Conditions**

温度：270±5°C

时间：10±1 sec.

Temp:270±5°C

Time:10±1 sec

**包装规格 / Packaging SPEC.**

散件包装 / BULK

Package Type 封装形式	Units 包装数量					Dimension 包装尺寸 (unit: mm3)		
	Units/Bag 只/袋	Bags/Inner Box 袋/盒	Units/Inner Box 只/盒	Inner Boxes/Outer Box 盒/箱	Units/Outer Box 只/箱	Bag 袋	Inner Box 盒	Outer Box 箱
TO-92	1,000	10	10,000	5	50,000	135×190	237×172×102	560×245×195
	1,000	10	10,000	10	100,000	135×190	237×172×102	560×245×375

编带包装 / AMMO

Package Type 封装形式	Units 包装数量					Dimension 包装尺寸 (unit: mm3)	
	Units/tape 只/纸带	Tape/Inner Box 纸带/盒	Rows/Inner Box 纸带层/盒	Inner Boxes/Outer Box 盒/箱	Units/Outer Box 只/箱	Inner Box 盒	Outer Box 箱
TO-92	3,000	1	120	10	30,000	328×230×42	小箱 480×346×235, 大箱 547×407×268

**使用说明 / Notices**